

Wireless World

AUGUST 1955

VOL. 61 No. 8

Tape Bookmark

THE rapid growth of tape recording for domestic and business purposes is largely due to the excellence of what is rather pompously called the tape transporting system. Mechanisms for winding the tape from one spool to the other are, generally speaking, remarkably effective; the clumsiest of us find little difficulty in operating even the cheaper and less refined machines.

Judging by letters from readers, however, the domestic tape recorder is widely thought to be deficient in one respect: it is difficult to "find the place" on the tape at which any particular item starts. True, some kind of rough-and-ready gauge is often provided, but it does not give precise location. Most home recordists make use of scraps of paper inserted, like a bookmark, between adjacent turns of tape. This method, though fairly adequate when the "fast wind" mechanism can be smoothly and accurately controlled, is often considered to be crude. What seems to be wanted by a wide circle of users is a device which, by mechanical, magnetic, electrical, or even electronic means, will indicate precisely the part of the tape required. Something much more precise than the classical bookmark is in fact called for.

A device that went a long way towards meeting these needs was described in *Wireless World* for April, 1955. This embodied a selector switch actuated by pads glued to the tape at appropriate positions. Another method, used in certain machines, calls for the use of a revolution counter.

Perhaps the most novel of the various place-finding suggestions put forward by readers is for a system of signals imposed on the tape and audible only during the "fast wind"—forward or back. The idea is that these pulse signals, which could be arranged according to a code, would be recorded at a very low frequency and so would not be heard (or at least would not be obtrusive) at normal playback running speed. This method has obvious attractions—and, probably, what might be considered equally obvious limitations and drawbacks. For one thing, it would not be readily applicable to existing machines in which the playback head is inoperative during "fast wind." However, the

method seems worth investigating—always assuming, of course, that no satisfactory alternative that is inherently simpler and cheaper can be devised.

Colour Television Experiments

TOO much significance need not be attached to the standards (set out on another page) chosen for the B.B.C. experimental transmissions in colour television, to begin in the autumn. It was more or less a foregone conclusion that a start would be made with a version based as closely as possible on the standards devised by the National Television Standards Committee of the U.S.A. The so-called "British N.T.S.C." system involves very little change or addition to the B.B.C.'s existing monochrome transmitters. Another factor which might well have influenced the decision is that there is now a large amount of American experience with this system on which to draw. Further, there can be no doubt that the technical elegance of the system is attractive, except perhaps for the complexity of the receivers that go with it. Presumably the main purpose of the experimental transmissions is to allow that section of industry concerned with receiver design and manufacture to carry out field tests and to gain practical experience of colour television.

So far there has been no mention of experimental transmissions using other systems. No doubt, however, these will come; there is no need to make an over-hasty decision as to what system is finally to be adopted in this country. Indeed, a regular colour service is not expected for a long time.

In considering these questions, it must be remembered that all factors affecting British television must finally be decided by the Postmaster-General, who, in his turn, is advised by the Television Advisory Committee. The T.A.C. has uncompromisingly recommended a compatible system, and the British N.T.S.C. standards of the forthcoming transmissions satisfy that requirement. However, there may well be a change of view on this subject before the time comes for making a final decision.

Growth of Aircraft Radio

IN the Golden Jubilee celebrations of the Royal Aircraft Establishment at Farnborough this year, a substantial proportion of the exhibits were concerned with radio aids to navigation, communication and the application of radio and electronic techniques to the guidance of rocket missiles and the simulation and computation of their performance.

An historical exhibit, arranged in chronological order, began with the Sterling Type 52A spark transmitter and the Model TF valve receiver (detector and 2 l.f. stages) of the 1914-18 war, and led up to the multi-channel crystal-controlled equipment in use to-day. One was reminded of the fact that although the possibilities of flying and of wireless communication were both realized at the turn of the century, a decade was to pass before they could come together. With the aerofoils and engine powers then available no designer, harassed as he was by thoughts of how best to save weight, could afford a second glance at the ship-and-shore type of equipment which was the stock-in-trade of the then infant radio industry.

There is still constant pressure from commercial and military aircraft designers to reduce the weight and size of radio equipment to make room for paying passengers or more armament, and this is being met by increasing miniaturization, which was adequately represented in the exhibition.

The current work of the Radio Department at R.A.E. covers a wide field including the development of sono-buoys (in which the noises of submarines are picked up by hydrophones and relayed to a searching

aircraft by radio) and the detailed investigation of the problems of installing aerials with reasonably omni-directional characteristics on high-speed aircraft.

Electronic methods, once a useful alternative to established methods of physical measurement, can now be said to dominate all branches of aeronautical research. They reach their zenith at Farnborough in the "Tridac" analogue computer for guided missile problems, which occupies the whole of a special building and calls for primary power of the order of hundreds of kilowatts for the functioning of its many circuit elements.

Disc Recording and Reproducing Characteristics

IT has often been said that the ideal disc recording or reproducing characteristic should be one which is also easily realizable with simple circuitry. This provision is met in the proposals contained in the revised British Standard 1928:1955 which gives curves for fine-groove and coarse-groove recordings, and formulae for their derivation in terms of the time-constants of simple R-C networks. These recommendations are based on C.C.I.R. standards and take into account the recommendations provisionally agreed by the International Electrotechnical Commission at their Philadelphia meeting last year.

The revised standard, which is obtainable, price 6s, from the British Standards Institution, 2, Park Street, London, W.1, includes specifications of commercial and transcription disc dimensions, stylus tip radii and concludes with a discussion of the arguments for standardization of the recording and/or the reproducing characteristic.

Radar Simulator

EQUIPMENT for the training of radar operators and for the synthesis of tactical air exercises without the use of aircraft has been designed and developed by C. E. G. Bailey and J. Somerset Murray in association with the Solatron Electronic Group, Ltd., Thames Ditton, Surrey.

Aircraft are represented by control units which feed signals (analogous to speed, rate of climb or dive, rate of turn and direction of flight) into a computer unit. This unit integrates the factors governing range, bearing and height and translates the result into pulses for transmission to one or more radar display units.

Extraneous effects such as tropospheric refraction can be taken into account, and there are facilities for simulating jamming, either of the reflecting type ("window") or of the active noise-generating type.

The essence of the design is flexibility so that future as well as current characteristics of aircraft performance and radar systems can be simulated.

Typical assembly of Solatron radar simulator units. The main cabinet houses the computers. A display unit is shown on top. In the foreground are two aircraft control units.

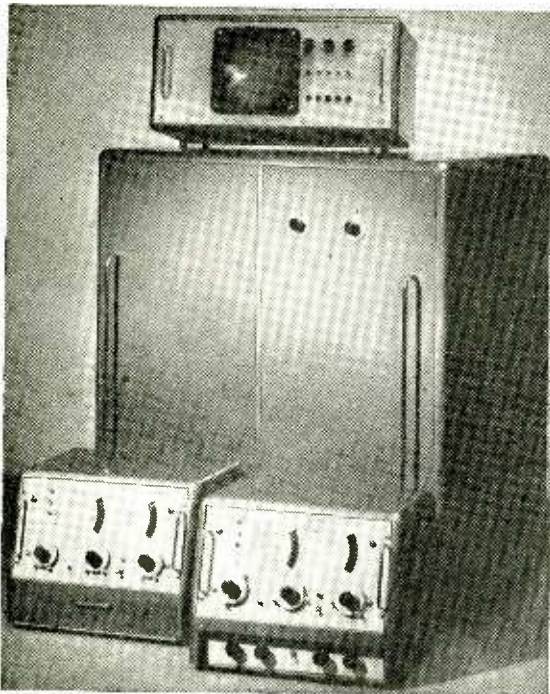

COLOUR TELEVISION STANDARDS

For Forthcoming B.B.C.

Test Transmissions

EXPERIMENTAL colour television transmissions based on the American N.T.S.C. compatible system will be made by the B.B.C. from Alexandra Palace this autumn as part of the general investigations into the best type of colour system for this country. A specification of the standards to be used shows the method of transmission to be a scaled-down version of the N.T.S.C. system, with the colour information transmitted by means of a sub-carrier within the existing 6.75-Mc/s monochrome channel.

An article on page 393 of this issue elaborates on the principles of the "British N.T.S.C." system, so it is unnecessary to add here more than the bare facts of the B.B.C. specification. First of all, the existing black-and-white transmission from Alexandra Palace will remain as it is and form the "luminance" or brightness component of the complete colour signal. Simultaneously a "chrominance" or colouring signal will be transmitted in the form of two sets of a.m. sidebands of two suppressed carriers in quadrature, these having the common frequency of 525/2 times the line scanning frequency relative to the 45-Mc/s picture carrier—in fact 2.6578125 Mc/s. These two "chrominance" components, known as the E_I and E_Q signals (see article) will carry respectively wide-band colour information up to 1 Mc/s and narrow-band colour information up to 340 kc/s.

The "chrominance" or colouring sync signal will consist of a reference burst of 9 cycles of sub-carrier frequency transmitted during the "back porch" black-level period following each line sync pulse. It will not occur during the eight broad pulses of the frame sync period. Details can be seen from Fig. 1, which shows that the sync burst penetrates into the picture region and that the "chrominance" signal can do the same and also rise above peak white.

The complete colour signal, in terms of the total

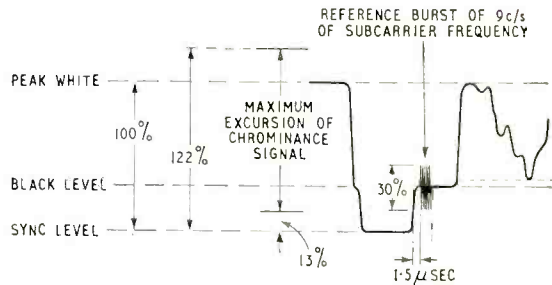

Fig. 1. Video waveform showing the relation of the added chrominance signal and sync burst to the existing monochrome signal.

video voltage applied to the transmitter modulator, is composed as follows:—

$$E_M = E_Y + K \{ E_Q \sin(\omega t + 33^\circ) + E_I \cos(\omega t + 33^\circ) \}$$

Here E_Y (the "luminance" or black-and-white signal) is made up of $0.3E_R + 0.59E_G + 0.11E_B$ while $E_Q = 0.41(E_B - E_Y) + 0.48(E_R - E_Y)$ and $E_I = -0.27(E_B - E_Y) + 0.74(E_R - E_Y)$. The angular frequency ω is 2π times the frequency of the "chrominance" sub-carrier, while the phase reference is the phase of the sync burst plus 180° . The factor K indicates that various ratios of "chrominance" to "luminance" between 1.0 and 0.3 may be used in certain experiments.

Comparative tests may be carried out with the system locked to and unlocked from the 50-c/s mains. With unlocked operation the sub-carrier frequency will be the 2.6578125 Mc/s mentioned above, but in the locked condition it, and the frequency difference between the vision and sound carriers, will change directly with the mains frequency.

The experimental transmissions will, of course, be made outside normal programme hours, and readers who manage to receive them will perhaps get a foretaste of the effect of compatible colour—detrimental or otherwise—on the picture quality we are used to at present.

SHORT-WAVE CONDITIONS

Predictions for August

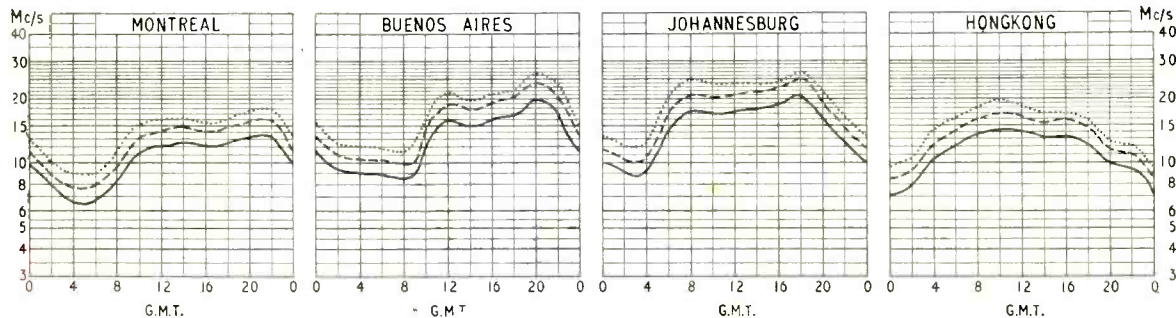

THE full-line curves given here indicate the highest frequencies likely to be usable at any time of the day or night for reliable communications over four long-distance paths from this country during August.

Broken-line curves give the highest frequencies that will sustain a partial service throughout the same period.

- FREQUENCY BELOW WHICH COMMUNICATION SHOULD BE POSSIBLE FOR 25% OF THE TOTAL TIME
- - - PREDICTED AVERAGE MAXIMUM USABLE FREQUENCY
- FREQUENCY BELOW WHICH COMMUNICATION SHOULD BE POSSIBLE ON ALL UNDISTURBED DAYS

WORLD OF WIRELESS

Show News ♦ Anglo-French TV Link ♦

New Television Stations

Earls Court

NEARLY 50 per cent of the 90 or so manufacturers who will be exhibiting at this year's National Radio Show are set makers; the others being makers of components and accessories. The remaining 30 exhibitors are either users of radio—such as the B.B.C., the Services and Government Departments—wholesalers, societies and associations, and organizations providing services for the industry.

The show opens at Earls Court, London, S.W.5, on August 24th for ten days, with a preview for overseas and invited guests on the 23rd.

In addition to the facilities provided on the exhibitors' stands for the demonstration of Bands I and III television sets, there will again be a display of some 100 receivers in Television Avenue. These receivers will be tuned to Band I. Incidentally, as in previous years, the Band I carriers piped round the show will be in Channel 4 to avoid interference from the London transmitter. Channel 8 is being used for the Band III demonstrations.

Each day at 2.30—except on Saturdays—a discussion meeting is being arranged by the British Radio Equipment Manufacturers' Association to bring together retailers' servicemen and representatives of the industry to discuss the servicing of f.m. receivers and the problems of f.m. aerial installation. Tickets must be obtained from B.R.E.M.A., 59, Russell Square, London, W.C.1.

Cross-Channel TV Link

THE first section of the permanent Anglo-French television link, ordered by the B.B.C. from the Post Office last January, will be completed in September. This section consists of a two-tube co-axial cable between London and St. Margaret's Bay, Kent. The next section, consisting of a two-way cross-Channel radio link, will not be completed for three years.

However, so that we can participate in international programme exchanges (the next is planned for this autumn) the cables will be extended temporarily from St. Margaret's Bay to Swingate, near Dover—a distance of about two miles—where a temporary cross-Channel radio station is set up.

It is understood that the cost of laying the cable, which is permanently rented by the B.B.C., and the cost of building the terminal station at St. Margaret's Bay will be nearly £750,000.

NATIONAL RADIO EXHIBITION WIRELESS WORLD SHOW NUMBERS

September: Show Guide. Plan of the stands at Earls Court, with stand-to-stand guide to the exhibits.

October: Show Review. An analysis of design trends in television and sound broadcast receivers.

TEMPORARY 200-ft mast carrying the 8-stack array for the Croydon I.T.A. transmitter. Marconi's are supplying the complete installation for the temporary station due to open on September 22nd. The mast was completed early in July and the sound transmitter is installed.

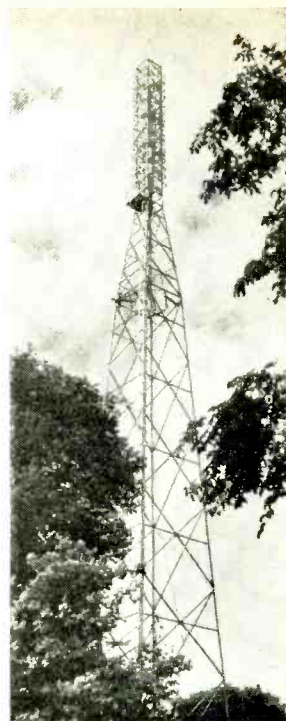

B.B.C. Television Progress

DURING the past few days the permanent television station at Divis, near Belfast, has been brought into service by the B.B.C. It replaces the temporary mobile station which has been in use at Glencairn for the past two years. The transmitter, which has an e.r.p. of 20 kW, shares Channel 1 (vision 45 Mc/s, sound 41.5 Mc/s) with Alexandra Palace.

It will continue to receive its programmes directly by radio from Kirk o' Shotts, Scotland. As has been done in the past, if the received picture is unsuitable for retransmission, or below standard, a warning signal—a vertical white bar—will be radiated. This warning signal is also being used by the Norwich transmitter which re-radiates London's transmissions.

The construction of the 640-ft self-supporting tower to carry the aerials for the new B.B.C. London station at Crystal Palace is well under way. At the 440-ft level will be installed parabolic aerials for receiving outside broadcasts. The Band I transmitting aerials—consisting of eight stacks of four dipoles—will be mounted on the section between 440 and 600-ft, above which there will be a 40-ft topmast. The tower is being erected by B. I. Callender's Construction and the aerial by Marconi's.

I.T.A. Links

A RADIO link is to be provided by the Post Office between Birmingham and the I.T.A. Midland station near Lichfield. It will provide two channels to Lichfield and one in the reverse direction. The Lancashire station at Winter Hill, near Bolton, will be linked with Birmingham by cable.

All the equipment for the radio link is being supplied by the G.E.C. who are also supplying the repeaters and terminal equipment for the cable link.

PERSONALITIES

Dr. Robert Cockburn, M.Sc., Ph.D., A.M.I.E.E., principal director of scientific research, guided weapons and electronics (M.o.S.) since March, 1954, has been appointed deputy controller of electronics in the Ministry in succession to Rear Admiral G. Burghard, whose tour of duty has expired. Dr. Cockburn, who is 44, was scientific adviser to the Air Ministry before joining the Ministry of Supply. For some time during the war he was head of the counter-measures group of T.R.E. and was awarded the American medal of merit for his work in this field.

Dr. A. L. Cullen, Ph.D., B.Sc., A.M.I.E.E., is to occupy the newly created chair of electrical engineering in the University of Sheffield. After graduating at the Imperial College of Science and Technology, London, in 1940, he joined the staff of the Royal Aircraft Establishment, Farnborough, where, until 1946, he worked on radar, being mainly concerned with aerials and waveguide techniques. He is at present reader in electrical engineering at University College, London, which he joined in 1946 as a lecturer. Dr. Cullen's special interest is microwave measurement techniques.

J. A. Smale, engineer-in-chief of Cable and Wireless since 1948, has been appointed by the government of Cyprus to be part-time chairman of the new Cyprus Inland Telecommunications Authority set up to administer and operate the island's inland telephone and telegraph services. He will continue in his present post with C. & W., visiting Cyprus as necessary.

H. R. Whitfield, M.I.E.E., who has been with Kelvin and Hughes, Ltd., as chief radar engineer since 1946, has been appointed a director of Kelvin Hughes (Marine), Ltd. In 1936, at the age of 19, he went to the Automatic Telephone and Electric Co., Liverpool, as a transmission laboratory engineer. From 1938 to 1940 he was a member of the War Department civilian technical staff attached to the Bawdsey (Suffolk) radar research station and then went to the research establishments, Malvern, as a member of the scientific staff on gunnery radar.

In addition to those mentioned in our last issue as having received Birthday Honours, **John N. Toothill**, general manager, Ferranti, Ltd., Edinburgh, was appointed C.B.E., **Horace D. McD. Ellis**, engineer in the B.B.C. Designs Department, was appointed M.B.E. and **William Fairhurst**, foreman, Electronic Tubes, Ltd., High Wycombe, received the British Empire Medal.

R. E. Burnett, M.A., A.M.I.E.E., A.Inst.P., has relinquished the principalship of Marconi College, Chelmsford, which he has held since 1950 and the position of manager of education and technical personnel on his appointment as full-time assistant to the general manager. His duties as manager of education and technical personnel will be undertaken by **E. R. L. Lewis**, M.A., A.M.I.E.E., who has been his deputy. The new principal of the college is **R. G. Hulse**, B.Sc., who has been deputy principal during the past year.

L. Hampson, who in this issue describes a Band II tuner unit, has been in the valve measurement and application laboratory of Mullard's since 1951. He joined Mullard's immediately after graduating at the age of 24 at Manchester University where he studied electrical engineering after completing his National Service. While at Mullard's he has been mainly concerned with development work on the application of valves in the v.h.f. bands.

After 36 years' service with Marconi's, **H. C. Van de Velde** has relinquished the position of deputy to the managing director of the Marconi Marine Company but will continue to represent the company on the boards of various associated companies overseas. With Mr. Van de Velde's retirement, **R. Ferguson**, the general manager, who joined the seagoing staff of Marconi's in 1910, is extending his managerial responsibilities. He was seconded to the M.W.T. Company in 1934 in order that he might

take up the appointment of general manager of Egyptian State Broadcasting which Marconi's conducted for the Egyptian government. On his return from Egypt he was re-appointed to the marine company, of which he became general manager in 1947.

F. G. Robb, chief of Marconi's Test Division since 1948, has retired after 36 years' service with the company. He was for some years in the designs and development section where at one time he worked on the development of beam transmitters for the Marconi-Franklin short-wave beam system. During the war he was seconded to the Admiralty and became chief of radar



R. FERGUSON



E. H. EVANS

test. His successor at Chelmsford is **E. H. Evans** who joined Marconi's in 1913. He has been associated with the test division throughout his service and for a number of years has been chief of receiver test.

Obituary.—The death occurred on July 9th of **L. F. Fogarty**, M.I.E.E., who was for many years honorary treasurer of the Wireless Society of London, of which he was a founder-member and then of the Radio Society of Great Britain as it has been known since 1922. He had been managing director of the Zenith Electric Company since its formation in 1918.

IN BRIEF

Receiving Licences Decrease.—Although there was a further increase of 43,192 television licences in the United Kingdom during May, there was an overall decrease of some 17,000 in the number of domestic receiving licences in force. The comparative figures for May and April—the latter in brackets—are: sound 9,102,995 (9,165,242), vision 4,623,917 (4,580,725), car radio 273,883 (271,480), total 14,000,795 (14,017,447).

G. A. Briggs, of Wharfedale Wireless Works, Bradford, whose two lecture-demonstrations in the Royal Festival Hall, London, have created a demand for tickets far in excess of the seating capacity of the hall (3,000), is going to New York to give a similar demonstration in the Carnegie Hall (seating 2,760) on October 9th. Capitol Records Inc. are to make the recordings required for comparing live and recorded performances of piano, violin and organ and, as at the R.F.H., Mr. Briggs will be working in collaboration with P. J. Walker.

At the annual general meeting of the **Television Society**, the following members were elected to fill the vacancies on the Council: T. W. Price (Ediswan), A. E. Sarson (Marconi's), W. R. Smith (G.P.O.), Professor Trewhman (E.M.I. Institutes) and C. B. Townsend (G.E.C.). In addition, D. N. Corfield (S.T.C.) and F. Livingston Hogg (Livingston Laboratories), who were co-opted last year, were elected full members.

B.A.T.C.—A convention of the British Amateur Television Club is being arranged for October 1st at the Bedford Corner Hotel, Bedford Square, London, W.C.1,

from 10 a.m. to 6 p.m. There will be a display and demonstration of members' equipment and a film show. Tickets (costing 5s) and further information can be obtained from D. S. Reid, 4, Bishop Road, Chelmsford, Essex.

Telesurance Limited, which operates a television insurance and maintenance scheme through registered R.T.R.A. dealers, has issued a statement on its policy regarding sets converted for Band III. No additional premium charges will be made providing the sets are converted by appointed dealers in accordance with the recommendations of the manufacturers.

The mains and output transformers and the smoothing choke specified by W. A. Ferguson for the **20-watt quality amplifier** described in our May and June issues, are being produced by Partridge Transformers, Limited, Roebuck Road, Tolworth, Surrey. A leaflet giving electrical and physical characteristics is available.

In preparation for the advent of commercial television a **television training centre** has recently been opened in London by Marconi's. It provides a complete training course in the operation and maintenance of television studio equipment. The centre is also available to organizations for rehearsals under operational conditions and a mobile unit is available for the production of recorded O.B.s.

Engineering Education.—Lists of colleges in London and the Home Counties providing engineering courses during the 1955/6 session are given in "Engineering Education in the Region" published by the Regional Advisory Council for Higher Technological Education. It includes sections covering engineering crafts (including radio and television servicing), City and Guilds courses in telecommunications engineering, H.N.C. courses in electrical engineering with a bias towards radio and telecommunications, and courses in direct preparation for I.E.E. and Brit.I.R.E. examinations. The 30-page booklet is obtainable (price 1s) from the Regional Advisory Council, Tavistock House South, Tavistock Square, London, W.C.1.

At the eighth annual presentation of diplomas at the **College of Aeronautics**, Cranfield, Bucks, where a chair in aircraft electrical engineering has now been established, nine of the 68 awards were gained by students specializing in aircraft electrical engineering. The theses covered work on computers, simulators, servomechanisms and on the properties of suppressed aircraft aeriels. As already announced, the first professor of the new department is G. A. Whitfield, who was at R.A.E. Farnborough.

"**The Inquiring Mind**" is the title of the documentary film sponsored by the I.E.E. for the purpose of depicting the diverse fields of opportunities open to electrical engineers. Copies of this 30-minute monochrome sound film, which is available in 35 mm and 16 mm, can be borrowed by schools, colleges and similar establishments. Particulars regarding the loan of the film are obtainable from the I.E.E., Savoy Place, London, W.C.2.

Nuclear Electronics.—During the forthcoming international conference at Geneva on the peaceful uses of atomic energy (August 8th to 20th) to which 84 nations have been invited, two exhibitions are being held. At one of these, which will be open to the public, a number of British electronics manufacturers will be participating and there will be a combined exhibit organized by the Scientific Instrument Manufacturers' Association.

R.E.C.M.F. Headquarters.—The Radio and Electronic Component Manufacturers' Federation has moved from Surrey Street, London, W.C.2, to 21, Tothill Street, London, S.W.1. (Tel.: Abbey 4226/8.)

Swindon.—With the object of forming a radio club in the town a meeting will be held on August 31st at 7.30, at the Connaught Café, 34, Cromwell Street, Swindon. Further particulars are obtainable from R. Reynolds, G31DW, 136, Beech Avenue, Swindon, Wilts.

Many demonstrations of high-quality reproduction have been given to gramophone and music societies and at public exhibitions by **Goodmans Industries** during the past few months. Societies interested in receiving a visit from the demonstration team are invited to write to Goodmans Industries Limited, Axiom Works, Wembley, Middx.

The third edition of the **CABMA Register** (1955/6) of British products and Canadian distributors again incorporates an alphabetical buyers' guide to some 4,000 British products, including radio and electronic equipment, available on the Canadian market. Other sections list manufacturers, trade names, Canadian distributors, etc. The register (price 2gns) is published jointly by Kelly's Directories and Iliffe and Sons for the Canadian Association of British Manufacturers and Agencies which operates British Trade Centres in Toronto, Vancouver and Montreal.

EXHIBITION NEWS

Next Physical Society Exhibition.—It is announced by the Physical Society that next year's 40th exhibition of scientific instruments and apparatus will be held in both the Old and New Halls of the Royal Horticultural Society, Westminster, London, S.W.1, from May 14th to 17th.

Marine Exhibition.—A number of radio manufacturers specializing in marine equipment or industrial electronic gear will be among the 500 exhibitors at the Engineering, Marine and Welding Exhibition which opens at Olympia, London, on September 1st for 13 days. Manufacturers appearing in the provisional list of exhibitors include B.T.H., Decca, English Electric (Electronics Division), G.E.C., I.M.R.C., Metropolitan-Vickers, Mullard, Radio Heaters, Redifon and Stratton. The exhibition will open daily from 10 a.m. to 8 p.m.

The dates for the ninth annual **Amateur Radio Exhibition**, organized by the Radio Society of Great Britain, have now been confirmed; November 23rd to 26th. It will again be held at the Royal Hotel, Woburn Place, London, W.C.1, and will be opened at noon on the 23rd by Vice-Admiral J. W. S. Dorling, director of the Radio Industry Council.

Midlands Radio Show.—The success of last year's Nottingham Radio Exhibition has prompted the organizers—the Nottingham Centre of the Radio and Television Retailers' Association—to broaden the scope of this year's show and to re-name it the Midlands Radio Exhibition. It will be held in the Ice Stadium, Nottingham, from September 19th-24th.

At the **British Exhibition in Copenhagen** (September 29th to October 16th) arranged jointly by the British Import Union, Denmark, and the Federation of British Industries, a large stand has been taken by the Radio and Electronic Component Manufacturers' Federation. Some twenty member-firms will be participating.

The **Model Engineer Exhibition**, with which is combined this year the Exhibition of Inventions, is to be held at the new Horticultural Hall, Westminster, from August 17th to 27th.

BUSINESS NOTES

Collins Radio, the well-known American manufacturers of aeronautical radio equipment, have formed a subsidiary in this country—Collins Radio Company of England, Limited. At present it is operating a service depot at Sunflex Works, Colham Mill Road, West Drayton, Middx. (Tel.: West Drayton 2226.)

Ekco-Dynatron Merger.—E. K. Cole, Ltd., have acquired a controlling interest in Dynatron Radio, Limited, of Maidenhead, Berks. It is understood that there is no intention of changing the policy of the business which is concerned with the manufacture of "above-average" domestic sound and television receivers.

EXPORT NEWS

The potential output of G.E.C. television receivers will be increased by 50 per cent with the rearrangement of production facilities in Coventry. The factory in Spon Street is being devoted exclusively to television and the production of domestic sound receivers is being transferred to another factory in the city.

The exclusive world distribution of acoustical equipment developed by **Kelly Acoustics Limited**, of 295, Regents Park Road, London, N.3, has been taken over by **Thermionic Products Limited**, Hythe, Southampton, to whom all enquiries for the new ribbon loudspeaker (RLS/1) should be sent.

Ampex Corporation, of California, manufacturers of magnetic-tape recording equipment, are to open an office in London. This and similar offices in overseas countries will be run by the recently formed company, Ampex International.

The "Radiovoyce" microphone equipment illustrated on p. 312 of our July issue, for which Leever-Rich Equipment Limited are sole marketing agents to the trade, is designed and manufactured by F. W. Hopwood (Developments) Limited, 181, Wollaton Street, Nottingham.

Truvox Limited announce that they have appointed A. B. Thompson (Ireland) Limited, of 15, Newforge Lane, Belfast, as Northern Ireland agents for their tape-recording components and accessories.

F. W. Electronics, Limited, of New Southgate, London, N.11, which was formed in 1950 and specializes in the design and manufacture of audio and r.f. equipment—including equipment for schools—has moved its works and registered office to 12a, Prince of Wales Road, Hendon, London, N.W.4. (Tel.: Sunnyhill 0683.)

Holiday and Hemmerdinger, Limited, of 74-78, Hardman Street, Deansgate, Manchester, 3 (Tel.: Deansgate 4121) have notified us that they have arranged with the Recording Equipment Division of E.M.I. Sales and Service, Limited, to distribute "Emidisc" lacquer recording blanks and accessories to the trade in the Manchester area.

The telephone number of **Nagard, Limited**, designers and manufacturers of electrical instruments for research and industry, of 18, Avenue Road, Belmont, Surrey, has been changed to Vigilant 9161.

The North-Western Gas Board, which operates two base stations at Manchester and Liverpool and 25 mobile radio-telephone installations, is now using a radio-equipped mobile "paying-in" office. The a.m. equipment being used in the vehicle, which periodically visits outlying districts, was supplied by the Radio & Transmission Division of **Automatic Telephone & Electric Company**. Two additional fixed stations are to be brought into operation by the Board to serve the Wirral and St. Helens areas.

Jack Davis (Relays), Ltd., is moving this month from Percy Street, London, W.1, to Tudor Place, Tottenham Court Road, W.1. Telephone numbers are unchanged.

HALF A MILLION television receivers have come off this assembly line at the Enfield, Middlesex, factory of Ferguson. The conveyors in the foreground are carrying completed chassis, after soak tests, to the section for final testing and adjustment.



Equipment for a public radio-telephone service in the three neighbouring territories of Sarawak, North Borneo and Brunei is being provided by **A.T.E. (Bridgnorth), Ltd.**, a subsidiary of Automatic Telephone & Electric Company, Ltd. More than 80 single-channel radio links will be required for the service which will link the outlying settlements and the divisional centres where line telephone services already exist. Eventually the main centres will be linked by a multi-channel radio system.

Redifon radio-telephone equipment is being fitted in ten of the vessels of the Niger river fleet of the United Africa Company and fixed stations will be set up at **Burutu, Makurdi, Yola and Garua.**

A radio network providing for 240 telephone circuits and a two-way 525-line television channel between Osaka and Fukuoka has been ordered from **Standard Telephones and Cables** through its associates the Nippon Electric Company, Limited, of Tokio. Eleven intermediate repeaters, working in the s.h.f. band (3,000-30,000 Mc/s), will be used to cover the 385 miles.

India's Director General of Supplies and Disposals (Shahjahan Road, New Delhi), has asked for tenders for **12,500 broadcast receivers** and associated aerial equipment and loudspeakers. The majority of the receivers are for dry-battery operation and must cover the medium-wave band although some of them must also cover the short waves. About 1,000 receivers are needed for a.c. operation. A copy of the tender documents is available from the Export Services Branch, B.o.T., Lacon House, Theobalds Road, London, W.C.1 (Reference ESB14288/55). Closing date for tenders is July 29th.

International Aeradio, Limited, has received from the Egyptian Air Force an order for three air traffic control desks. I.A.L. is also providing the radio and air traffic control services at Yeadon Airport, near Leeds, which is to be developed to provide scheduled and charter air services.

Airfield control radar equipment (Type 424) is to be supplied by **Decca Radar, Limited**, for installation at Durban National Airport. This surveillance radar equipment, which was reviewed in our November, 1953, issue, was also recently supplied to the South African Air Force.

R. B. Page, of Birmingham Sound Reproducers, Ltd., is on a three-month visit to North America to renew acquaintance with radio-gramophone manufacturers.

Inexpensive Wave Analyser

“Zero-beat” System Using Simple Low-Pass Filter

By M. G. SCROGGIE, B.Sc., M.I.E.E.

IN a recent survey of distortion-measuring technique¹ it was noted that published data on distortion usually take the form of a single figure (“total harmonic distortion”) whereas for fair comparison one must know about the individual distortion products (whether harmonics or intermodulation) making up this total. One reason for the scarcity of analysed data is no doubt the high cost of wave analysers. In order to measure each distortion product separately it is necessary to have extremely high selectivity, which cannot reasonably be obtained by straightforward a.f. tuning capable of being varied continuously from, say, 20 c/s to 20 kc/s. The difficulty is usually overcome in the same way as in the analogous r.f. problem in radio receivers, with the aid of the superheterodyne principle. By means of a beat oscillator, the frequency of the chosen component of the signal being analysed is transferred to an “i.f.” which might be 50 kc/s; components of all other frequencies are then removed by a filter having a pass band of only a few cycles per second, and after amplification the selected signal deflects an indicating meter.

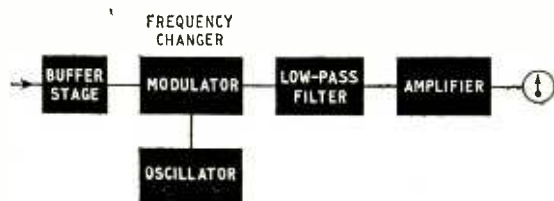

Fig. 1. Block diagram of the type of wave analyser described.

The heart of the instrument is the filter, because on it the capabilities of the wave analyser chiefly depend. For testing high-fidelity equipment it is necessary to measure distortion components of the order of 0.1% (i.e., 60dB down) relative to a fundamental output separated in frequency by perhaps 25 c/s, which relative to 50 kc/s is 0.05% off-tune. At the same time, in order not to render the analyser too tricky to use, or make unreasonable demands on signal-frequency stability, the filter characteristic ought to be flat-topped. Such onerous requirements, calling for carefully applied crystal resonator technique, have no doubt deterred many experimenters from running up an analyser for themselves.

Continuing the radio receiver analogy, we might remember that there is such a thing as a synchrodyne,^{2,3} which can be defined as a superhet in which the i.f. is zero. An advantage therein is that instead of the usual highly selective band-pass i.f. system a simple low-pass filter will do. This seems just what is wanted for a wave analyser. Providing a filter to cut out everything above one or two cycles per second presents no difficulty at all. In fact, on top of a

great saving in expense, it is easy to obtain substantially higher effective selectivity than in a conventional wave analyser, yet at the same time adjustment is less critical.

One inherent disadvantage of the principle ought perhaps to be declared at the outset. In a frequency changer, harmonics of the oscillator frequency are likely to be present. These, in a wave analyser with an i.f. of the order of 50 kc/s, are too far up in the r.f. region to give i.f. beats with any a.f. (the “bias” frequency in a tape recorder must be watched, however). But in the zero-i.f. type of frequency changer, in which the desired response is obtained by setting the beat-oscillator frequency very nearly equal to that of the signal component to be measured, smaller responses can also occur at multiples (especially odd multiples) of the frequency read. One must therefore take some care to choose signal frequencies that cannot yield misleading responses.

What might be considered to be another disadvantage is that if one desires to cover the full a.f. band the beat oscillator has to be variable over a large tuning ratio, say 1000:1, as compared with less than 2:1 in the conventional system. On the other hand, however, the fact that the beat oscillator frequency at zero-beat is exactly the same as that of the component being measured makes for much easier frequency adjustment and more accurate and stable frequency calibration, which are decided advantages.

Fig. 1 is a block diagram of a zero-i.f. wave analyser. When measuring very weak distortion products, some amplification ahead of the frequency changer could be helpful, but it is even more important not to add to the distortion before it is measured. Some sort of buffer stage is essential, in order to make the input impedance large enough not to impose appreciable loading on the signal being analysed and at the same time to present to the modulator an output impedance low enough not to introduce appreciable distortion. These requirements are met by a low-resistance cathode follower.

Type of Oscillator

The modulator is a bridge comprising four rectifiers, shunted diagonally across the signal path. The design of the beat oscillator, which is connected across the other diagonal, depends on requirements. For experimental purposes an a.f. generator previously described⁴ was more than adequate, and enabled results using square waves to be compared with those using sine waves. For routine tests along the lines suggested, however, a simple fixed-frequency oscillator could be used. A 3-valve oscillator like either of the two shown in Fig. 6 is very suitable for either fixed or variable frequency.

Because the mechanical movement of the indicator

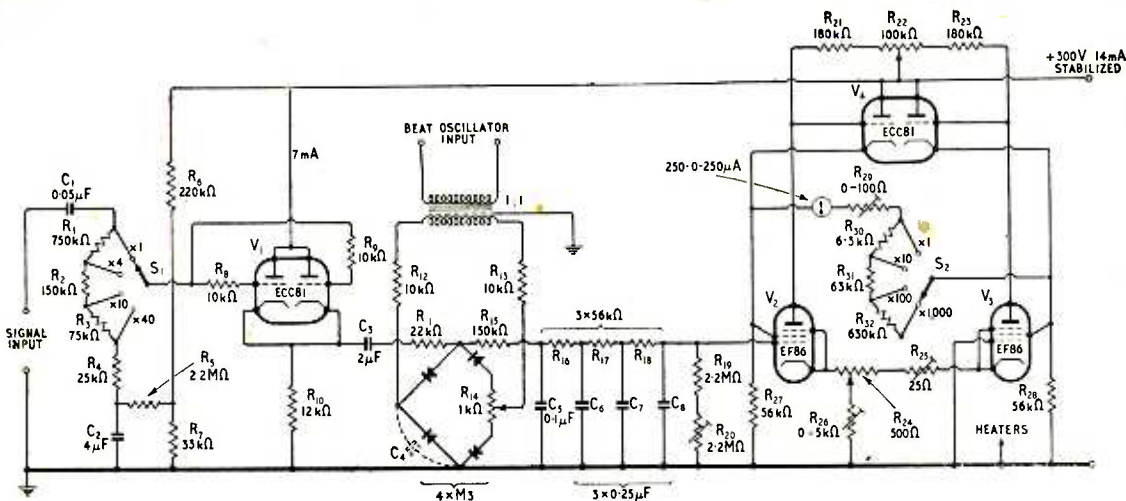

Fig. 2. Circuit diagram of a particular development of Fig. 1.

is itself a low-pass system, a very simple and cheap resistance-capacitance filter is all that is needed between modulator and amplifier. It was this amplifier that presented the greatest difficulty. At first it was supposed that two resistance-coupled stages with the time constants adapted to pass a band of the order of 0.2 to 2 c/s, or a balanced amplifier with heavy negative feedback except over this band, would be a suitable basis for design. By cutting out zero frequency it was hoped to obtain a stable meter zero, but it was found that even in a push-pull system it was impracticable to balance the long time constants sufficiently to avoid perpetual slow drifts, and in spite of the zero-instability problem a d.c. amplifier was actually more workable. Stabilized power supplies are of course necessary in any case.

The design can now be discussed in detail with reference to the circuit diagram, Fig. 2, which is subject to modification to suit individual needs. In order to provide a low output resistance (about 130 Ω) at a moderate anode current (7mA) the cathode follower comprises both halves of a high-slope double triode. The distortion caused by it is too small to estimate precisely; but the total residual intermodulation, which with two input signals of different frequency, each 2½V peak, is of the order of 0.05% is perceptibly increased if only one half is used. Without R₈ and R₉ there is a tendency to parasitic oscillation. The time constant C₂ R₅ has a valuable stabilizing effect in preventing short-term fluctuations in h.t. voltage from reaching the grid. C₂ has in any case to be fairly large for its impedance at the lowest input frequency (reckoned as 20 c/s) to be negligible in relation to R₄, the lowest step of the input potential divider, which functions as a scale multiplier. Obviously the switch controlling it, S₁, should be of the make-before-break type.

The modulator (known as a Cowan type ^{2,3}) is made up of four Standard Telephones M3 miniature selenium rectifiers. Under the influence of the beat oscillator their resistance becomes alternately much higher and much lower than R₁₁, so that the signal from the cathode follower is alternately passed to the filter and suppressed. When the signal contains a frequency exactly equal to that of the oscillator, and in phase, the component of the signal at that frequency

Fig. 3. Signal waveforms across the modulator, (a) according to simplified theory, and (b) as modified in practice by C₃ (Fig. 2). The dotted portions of the original waveform are suppressed. In (b) the horizontal portions indicate the displaced zero level.

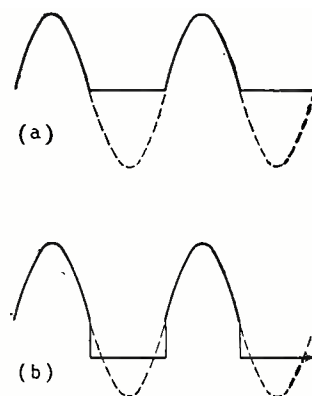

is in effect rectified. If the phase is reversed, the direction of rectification is reversed. So if the signal frequency is altered by, say, 1 c/s, a 1-c/s signal is created by the slowly shifting phase relationship. This signal is accepted by the filter, the original signal being rejected.

Modulation Wave Shape

If the action were quite as simple as just described, the waveform across the modulator, with the beat oscillator in phase with a sinusoidal incoming signal, would be as in Fig. 3(a), where the dotted line traces the suppressed half-cycles. This condition corresponds to the peak value of the beat-frequency signal, which is clearly equal to the mean value over a whole cycle of one half cycle of the incoming signal, or 1/π times its peak value. The theoretical efficiency, neglecting all losses, such as those due to the finite resistance of the rectifiers, would therefore be barely 32%. In reality, however, C₃ modifies the action in a manner analogous to that of the reservoir capacitor in an ordinary rectifier circuit, displacing the waveform upwards and increasing its mean value and therefore the efficiency. To obtain the greatest benefit from this, the beat oscillator should have a pulse waveform, so that (just as in the rectifier circuit) the charging of C₃ is concentrated at the peak

of the input signal. After investigation it was decided that the increase in efficiency was not worth the trouble of providing the special beat-oscillator waveform and ensuring constancy of its positive/negative time ratio at all frequencies. The undesired responses are also more liable to be troublesome, because if the waveform ratio is $m:1$ the only harmonics suppressed are integral multiples of $m+1$. Using a $1:1$ waveform thus suppresses all even harmonics. Both for this reason, and in order to obtain constant efficiency, it is advantageous to preserve an accurate $1:1$ ratio. This is easier to do with a sinusoidal waveform than with a square; so although the square gives the quickest switch-over for a given peak value, and consequently slightly lower residual intermodulation than an equal sinusoidal voltage, the latter was chosen on balance. The resulting signal waveform is as Fig. 3(b), and the measured efficiency (inclusive of the cathode follower) 52%. For comparison, the efficiency with a $4:1$ oscillator waveform was 75%.

The time constant C_3R_{11} is important, because it must be long compared with the period of the lowest signal frequency and short compared with that of the highest beat frequency. Since the optimum R_{11} depends on the backward and forward resistances of the rectifiers, a suitable time constant is obtained by choice of C_3 .

The higher the oscillator voltage the greater the signal voltage that can be handled linearly, but of course it must be within the maximum rating for the rectifiers, which is 56V peak inverse per rectifier, or 112 for the bridge, less an allowance for inequality of backward resistance. The signal voltage being read is limited by the amplifier to about 10V peak, and for that a sinusoidal oscillation of 20V r.m.s. is sufficient. To allow a margin of amplifier linearity, the maximum reading has been reckoned as that which is given by 6V r.m.s. at the input with S_1 at $\times 1$. Provided that S_1 is not moved to a more sensitive setting than that at which the strongest signal component is within the 6-V limit, the peak value of the whole signal at the modulator is not likely to exceed about 20, and using 28V r.m.s. (40V peak) for modulation it has been checked that this amount of signal voltage does not appreciably affect the accuracy of reading (e.g.) a 4mV component of it. It may, however, make it rather less easy to read, and 10V peak is a more conservative limit. The mean rectified current in the transformer secondary at 28V r.m.s. is about 0.5mA, which is well below the rated maximum of 1mA per rectifier. Linearity of the modulator is excellent.

Meter Zero Stabilization

In theory, this type of modulator automatically balances out the rectified and oscillator-frequency voltages from the signal path, but owing to inevitable inequalities in rectifier characteristics there is in practice a residue of both. A reasonable amount of this has not been found to cause appreciable error, but even a very small residual fraction of the total rectified (z.f.) voltage is enough to displace the pointer considerably. That in itself could be taken up on the amplifier balancing adjustment (R_{24}), but unfortunately the z.f. residue tends to vary with oscillator frequency, so that every change of frequency necessitates readjustment of meter zero. This nuisance can be more or less eliminated by (1) winding the

transformer in the manner recommended for impedance bridges—with the secondary in two identical halves, balanced with regard to earth (represented mainly by the inter-winding screen);* (2) using the balance control R_{14} ; and (3) connecting a capacitance C_4 across one of the rectifiers. This capacitance, of the order of 100pF, has most effect at high frequencies. The procedure is to adjust R_{14} so that switching on the beat oscillator at some medium or commonly-used frequency (say about 400 c/s) causes no displacement of the meter on the most sensitive range; then to vary the oscillator frequency and try various values and positions of C_4 to minimize shift when the frequency is raised. One of the advantages of tests at a single frequency¹ is that no special transformer or other precautions are needed. Also the advantages of a square modulating waveform can be obtained without most of the disadvantages.

The component values of the filter are not critical, but obviously R_{15} must be large compared with R_{11} if efficiency is not to be lost. As an example of the selectivity obtained by the simple means of this instrument, reading an input of 2.5mV at any frequency is quite unaffected (except for a very slight vibration of the pointer) by the presence of 4,200mV (i.e., 65dB stronger) only 30 c/s away.

Negative Feedback

At first glance the amplifier circuit may look rather like that of the valve voltmeter described in the August 1954 issue, but whereas in that circuit the whole voltage gain was sacrificed in the interests of stability by connecting the output terminals straight back to the control grids of V_2 and V_3 , here a large voltage gain is needed in order to be able to measure small distortions, and the only negative feedback is that which results from feeding the screen grids of V_2 and V_3 from the output terminals. This policy not only saves a special potential divider for the purpose, but it provides some degree of zero stabilization, and lowers the output resistance of the amplifier, giving a more stable calibration. The resistance of the 250-0-250 μ A meter is 500 Ω , and the output resistance of the amplifier about 160 Ω ; R_{28} is used to bring the whole up to a level of 700 Ω , so that R_{30} - R_{32} with the values stated give decade ranges by means of S_2 .

R_{26} is used to set the valves to suitable working points, indicated by the total amplifier h.t. current being about 7mA. R_{24} is used as a coarse balancing or zero-setting control and R_{25} the fine control. The additional balancing facility afforded by R_{22} is not absolutely essential, but is quite helpful in arranging the best working condition.

Without R_{19} and R_{20} the system was found to give full-scale swing on the $\times 1$ ranges of S_1 and S_2 for 9mV r.m.s. input at the selected frequency. By means of R_{20} this is pre-set to a convenient 10mV, the scale having been provided with a 10-0-10 marking. On the $\times 1,000$ setting of S_2 the meter is therefore direct reading in volts, but (as already explained) should not be used above 6 on this range.

The overall voltage gain of the amplifier is thus about $\times 24$. Although not large by higher-frequency standards it can cause quite a lot of trouble unless care is taken with regard to zero stability. The balanced circuit of course goes a long way towards

* A suitable transformer can be obtained from the Majestic Winding Co., 180 Windham Road, Bournemouth.

achieving this and those inexperienced with d.c. amplifiers may perhaps wonder why it does not go all the way, since it might appear that any change in supply voltages would affect both halves of the system equally and therefore would not affect the meter. But a little calculation shows that a perceptible displacement of the pointer—say $10\mu\text{A}$ —results from a difference between the anode currents of V_2 and V_3 of only about $0.05\mu\text{A}$. Now although any initial difference can of course be corrected by R_{21} or R_{22} , it would be too much to expect the anode currents of even a well-matched pair of valves to vary equally within $0.05\mu\text{A}$ over a range of anode, screen and heater voltages.

Any reasonably effective stabilizer for the source of the 300V h.t. should be able to eliminate zero-shift due to variations in anode and screen potentials of valves V_1 - V_4 , but the provision of R_{22} in addition to R_{24} makes assurance doubly sure; by successively shifting the setting of one and recentring the meter pointer with the other, an adjustment can be found at which even several volts change in h.t. has little effect on the meter, and protection is thus obtained against transient fluctuations of voltage of an inferior stabilizer. Protection against such transients (but of course not against long-term drifts) via the grids of V_1 is given by C_2R_5 . Trouble due to small fluctuations of h.t. is thus confined almost exclusively to the cathode current of V_1 , and it is for this that stabilization of the supply is chiefly needed. Even here an exceptionally high standard is not essential, thanks to the stabilizing effect of the negative feedback.

Incidentally, in case it occurs to anyone to extend the balanced-circuit principle all the way, as in Fig. 4, it should be mentioned that this causes the full signal voltage from V_1 to be applied between the grids of V_2 and V_3 and earth, thereby prematurely overloading

the amplifier on its most sensitive range. Moreover differences in time constants cause h.t. fluctuations to be more, rather than less, troublesome.

Although changes in oscillator amplitude affect the meter by upsetting the adjustment of R_{11} , it has not been found necessary to stabilize the oscillator power supplies, sufficient control being provided by the thermistor.⁴

Except for very low frequency fluctuations that may come in with the signal, the remaining cause of zero instability is the heater voltage. Its effect on V_4 is slight. On V_1 it is more troublesome; a 5% change in V_h was found to cause $100\mu\text{A}$ zero shift on the most sensitive range. But the effect is most serious as regards V_2 and V_3 . The simple device of differentially adjusting the heater voltages of the two valves, for which very good results have been claimed with triodes,⁵ was found to be quite ineffective, at least as regards the few samples of EF86 available. If one is not so fortunate as the writer to pick two valves that are well matched, not only as regards the ultimate

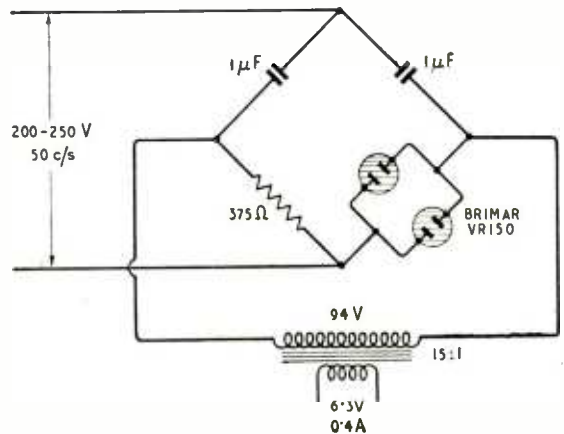

Fig. 5. Cherry and Wild stabilizer for the heater supply to V_2 and V_3 , if found necessary. The VR150 tubes in parallel are connected anode to cathode.

inequality in anode-current change caused by a heater-voltage change, but also in the rate at which the anode-current change occurs, it is advisable to stabilize the heater voltage of at least these two valves. If it can be stabilized for all the heaters, so much the better; but stabilization of V_2 and V_3 only is suggested as a second-best, because the comparatively simple Cherry and Wild system⁶ provides sufficient output for these two heaters. Fig. 5 shows the circuit, which was found to be amply effective for badly matched valves, giving a stabilization ratio of the order of 30 : 1.

Type of Meter.

Heater-voltage stabilization is rendered ineffective if there is instability of heater-circuit resistance, so good valve-holder contacts are essential; it would be better, if suitable valves with wire leads were obtainable, to solder them in without holders. Of course the whole of the circuit, especially from signal input to the grid of V_2 , must be free from uncertain contacts, leakages and stray pick-up; for example, all capacitors should have high and constant insulation resistance, and their cases should be earthed.

Lastly, there is the indicator itself. A 2-in dia.

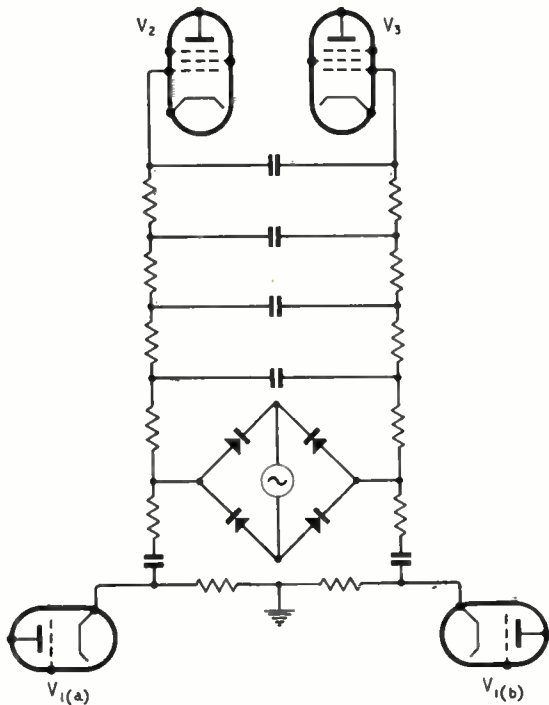

Fig. 4. Alternative, but less satisfactory, arrangement of the circuit up to the d.c. amplifier.

0-500 μ A meter, adjusted to a centre zero, was found to have a suitable combination of electrical and mechanical characteristics. Owing to the automatic limitation of current by the circuit, a more sensitive instrument could be used without risk of accidental damage, but there would be no point in doing so, because the minimum effective reading is already limited more by instability of zero and residual distortion than by insensitivity of the meter. Damping of the movement must be enough to suppress resonance without causing excessive sluggishness. The higher the frequency at which the pointer can oscillate without serious error (10% or even 20% is a not unreasonable tolerance in distortion measurements), up to the rate at which reading its amplitude of swing becomes difficult for the eye, the less critical is the adjustment of the signal frequencies and the demands on oscillator frequency stability. In practice a beat period of several seconds per cycle is about right.

Intermodulation Twin Oscillator

Coming now to the signal source, the chief requirement is stability and ease of adjustment of frequency. Dependable frequency calibration is a great help, particularly in identifying and avoiding spurious responses. For measuring harmonics, very pure waveform is obviously needed; this is not so necessary with intermodulation, the errors caused by harmonic content then being only of a second order of magnitude. The three-valve circuit forming the nucleus of the a.f. source already mentioned has proved to be simple and reliable, with quite phenomenal frequency and amplitude stability. A double oscillator for intermodulation measurements, hastily put together without any special care, using ordinary components, has often been set to give a slow beat, at, say, 0.3 c/s, and has continued to maintain this rate, without perceptible change, for hours on end. As regards purity of waveform, the second harmonic is about 0.25%, third 0.3%, and all others negligible. This performance was obtained notwithstanding that six old EF50 valves were substituted for the SP61 used in the original signal generator, whose harmonics are about half as great. The suitability of EF80 valves was checked by plugging them in, via adapters, in place of the EF50; no readjustment was necessary; the total h.t. consumption for the two oscillators was increased from 40 mA to 46 mA, and the harmonic content nearly halved. In every way, therefore, this circuit is eminently suitable as a signal source for intermodulation measurements in conjunction with the wave analyser. Fig. 6 is the circuit diagram.

For economy as regards the ganged inverse semi-log rheostats, the frequency ratio on each range was

reduced from the 10 : 1 in the original model to about $3\frac{1}{2}$: 1; this also slightly facilitated the all-important precision in frequency setting, but the fine controls (R_2) are chiefly relied upon for close adjustment. For the purposes in view, complete coverage of the full a.f. band by both oscillators was unnecessary, and the ranges are as given in Table I.

If lower frequencies were included it would be necessary to increase the values of the coupling capacitors accordingly.

Apart from these modifications of the original design, concerned with frequency coverage, the only new consideration was the necessity for combining the two signals in the output, without giving rise to intermodulation. With the direct mixing system shown in Fig. 6, there is just perceptible intermodulation, and if one wants to avoid this one can substitute a bridge or hybrid-coil system, but the improvement was found to be hardly worth while. It can be shown that, given equal outputs from the two oscillators, the ratio of their voltages at the common output terminals is equal to the ratio in which R_{15} - R_{21} is divided by S_2 (where these resistances include the internal resistances of the oscillators, which, being cathode followers in this case, are negligible). If therefore tests are usually made with either a 1 : 1 or 4 : 1 ratio, it is convenient to provide tapplings as shown. This does not prevent any other desired ratio from being set up by the separate controls (R_{14}); the level of the combined signal can then be varied without change of ratio by R_{22} .

Avoiding Spurious Effects

The frequency-selecting section of each oscillator should be enclosed in a screen; it is particularly necessary to remove stray capacitance between the two sections, as failure to do so may cause a small signal from one oscillator to appear at the output even when its own R_{14} is at zero. No difficulty was found, however, in running the twin oscillator unit from the same stabilized power supply as the wave analyser.

Residual intermodulation of modulator, input cathode follower, and signal-oscillator output circuit was checked in turn by first feeding the modulator with a single 420c/s signal from oscillator 2 via analyser cathode follower in series with the secondary of a step-down mains transformer giving a 50c/s signal, each signal being adjusted to give a reading of say 2V on the analyser meter. Intermodulation signals were looked for at 420 ± 50 and 420 ± 100 c/s, and were barely perceptible on the most sensitive range. The 50c/s source was then transferred to the lead between signal oscillator and analyser cathode follower. Lastly, the test was repeated with the 50c/s² mains source replaced by oscillator 1. Overall intermodulation using a sinusoidal beat-oscillator waveform, was 0.1% second order and 0.08% third order. With a 1 : 1 square waveform the figures were 0.04% and 0.02% respectively.

Of spurious responses, the most important are those resulting from signals at multiples of the frequency being read, which is the frequency of the beat oscillator, denoted by f_b . Using a 1 : 1 waveform ratio, the responses due to signals at even multiples of f_b are theoretically absent, and those at odd multiples (frequency = nf_b) are one n th of the amplitude resulting from an equal amplitude signal at f_b . In practice this is approximately true of the odd multiples, but although the even-multiple responses are relatively

TABLE I.

Range	Oscillator 1		Oscillator 2	
	Frequency	Capacitance	Frequency	Capacitance
1	40-120 c/s	0.1 μ F	350-1,100 c/s	0.0115 μ F
2	350-1,100 c/s	0.0115 μ F	1,000-3,200 c/s	0.004 μ F
3	3-10 kc/s	1,330 pF	3-10 kc/s	1,330 pF
4	9-25 kc/s	450 pF	9-25 kc/s	450 pF

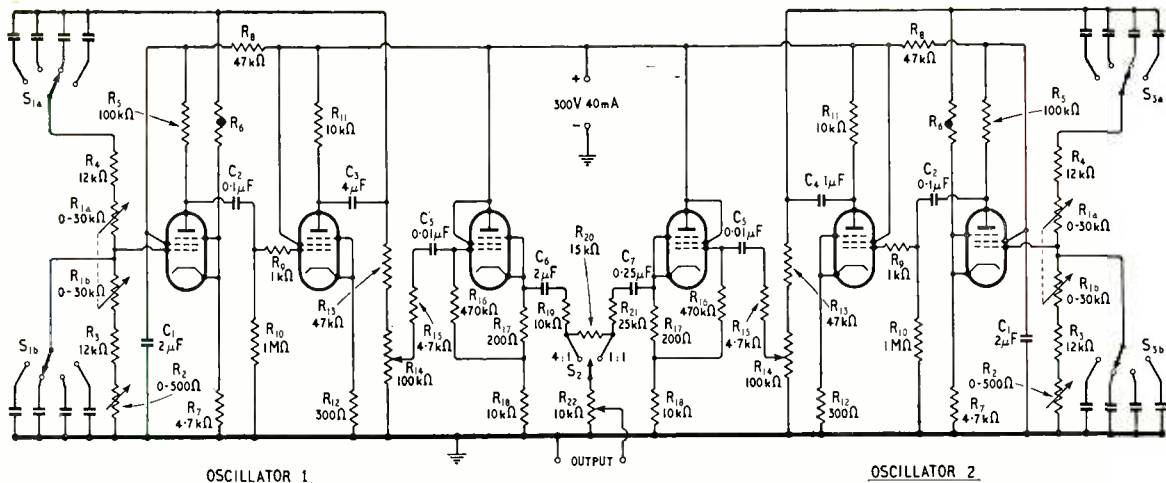

Fig. 6. Circuit diagram of a twin signal source for making intermodulation measurements in conjunction with the wave analyser. The thermistors (R_6) are Standard Telephones type A5513/100, and the valves all SP61, EF50, EF80 or equivalent. S_1 and S_3 are 2-pole 4-way frequency-range switches; the capacitances selected by pole b are the same as by pole a, and typical values are given in Table 1. Components in Oscillator 2 having the same values as the corresponding components in Oscillator 1 bear the same numbers.

small (<5% of the true response) their existence ought not to be overlooked.

When analysing signals it is inevitable sometimes that the component being read will be accompanied by another component at a multiple of its frequency, in which case an error must result. Fortunately it is seldom large enough to be appreciable. One reason for this is that, taking the odd and even harmonic series separately, their amplitudes almost invariably decrease more or less rapidly with frequency; another is the decreasing response of the analyser, which almost wipes out the even series and greatly discriminates against the odd.

In the very unlikely event of a sixth harmonic not being small compared with a second harmonic, it might (being three times the frequency) appreciably affect the reading of the second. But the only troublesome situation that is at all likely in practice is the measuring of a fundamental accompanied by a very large percentage of third harmonic. This situation is revealed by the non-sinusoidal swinging of the pointer, for the third harmonic in the signal is represented (though at only one third the amplitude) by a third harmonic of the slow beat frequency, and the effect of this harmonic can be still further reduced by bringing the fundamental beat frequency to the point beyond which response falls off rapidly.

In choosing f_1 and f_2 , the lower and higher signal oscillator frequencies for intermodulation tests, one would of course avoid making any of the components to be read— $f_2 \pm f_1$, $f_2 \pm 2f_1$, etc.—equal to a multiple of f_1 or f_2 . Fractional relationships between f_1 and f_2 would also be avoided; e.g., if f_1/f_2 were $2/5$, $f_2 + 2f_1$ would clash with $f_2 - f_1$, being its three-fold multiple. Doubt about whether or not a response is due to intermodulation can be dispelled by checking that the beat frequency responds to an adjustment of both f_1 and f_2 .

Pick-up from the mains is another possible cause of undesired responses, and 50c/s and its multiples (especially odd) are to be avoided as signal frequencies.

It has been interesting, in using this wave analyser, to confirm the experimental measurements by Warren and Hewlett⁷ of the ratio of intermodulation to

harmonics with amplifiers having various kinds of distortion and level frequency characteristics. Since the wave analyser reads only the sum or difference frequency and not both at once, the ratios are half those obtained by Warren and Hewlett with the same relative signal amplitudes (which were in the ratio 5 for harmonic to 4 and 1 for intermodulation measurement). With a single triode, giving almost pure second-order distortion, the amplitude of the component at $f_2 + f_1$ or $f_2 - f_1$ is 1.6 times that at $2f_1$; and with a push-pull amplifier, giving mainly third-order distortion, the amplitude ratio of $f_2 + 2f_1$ or $f_2 - 2f_1$ to $3f_1$ is 1.92. When negative feedback is used, distortion is of course greatly reduced; but if the signal amplitude is then raised to reintroduce distortion, its onset is more rapid, and instead of being concentrated mainly in second or third or both, it continues far up the series with comparatively slow convergence, and the aural unpleasantness is worse.

While admittedly a keen ear is the only instrument that is valid in the final assessment of sound reproduction, instrument readings are of very great value if properly taken and interpreted; and if analysed measurements rather than lumped were more generally made the much-needed establishment of accepted correlation between instrument readings and listening tests would assuredly be speeded up.

REFERENCES

- 1 Scroggie, M. G., "Measurement of non-linearity distortion," *Wireless World*, July, 1955, p. 317.
- 2 Tucker, D. G., "The Synchrondyne," *Electronic Engineering*, March 1947, p. 75.
- 3 "Cathode Ray," "The Synchrondyne," *Wireless World*, Aug. 1948, p. 277.
- 4 Scroggie, M. G., "Audio signal generator," *Wireless World*, Aug. 1949, p. 294, and Sept. 1949, p. 331.
- 5 Aitchison, R. E., "A new circuit for balancing the characteristic of pairs of valves," *Electronic Engineering*, May 1955, p. 224.
- 6 Cherry L. B., and R. F. Wild, "Electronic a.c. power regulator," *Proc. I.R.E.*, April 1945, p. 262.
- 7 Warren, W. J., and W. R. Hewlett, "An analysis of the intermodulation method of distortion measurement," *Proc. I.R.E.*, April 1948, p. 457.

TRANSISTOR SYMBOLS

SUGGESTIONS for the symbol to be used for the transistor have appeared from time to time in *Wireless World*, and especially in the April and May issues (pp. 151 and 201). Another symbol of an interesting kind is used in *L'Onde Electrique* (March-April, 1955, pp. 243-263). The symbols for *n-p-n* and *p-n-p* junction transistors are shown in the figure, at (a) and (b) respectively. Plus signs are used to designate p-type material and minus signs for n-type.

Since the emitter, as their source, contains more charge carriers than the collector (by those leaving through the base), the emitter and collector are distinguished by two signs and one sign respectively.

The full sign complement of (a) and (b) is actually unnecessary, for the base material is always of opposite kind to the emitter and collector. One can, therefore, omit the signs on the base and reduce the symbols to the form (c) and (d). This is quite commonly done in the article in *L'Onde Electrique*. A further modification consists in replacing the signs by dots as in (e). This is done when one wants to designate a transistor without being specific about whether it is a *p-n-p* or an *n-p-n* type.

There is still some redundancy, however, and the symbols could be reduced to (f), (g) and (h) without

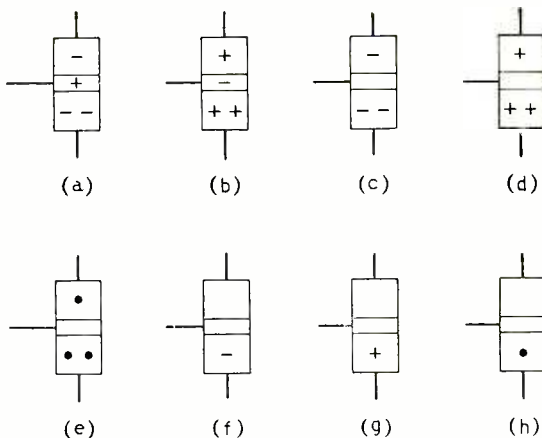

losing anything. The convention here is to mark only the emitter by a sign indicating the nature of the charge carriers, so (f) is for an *n-p-n* transistor, (g) is for a *p-n-p* and (h) is a general symbol for either.

DECCA NAVIGATOR EXTENSIONS

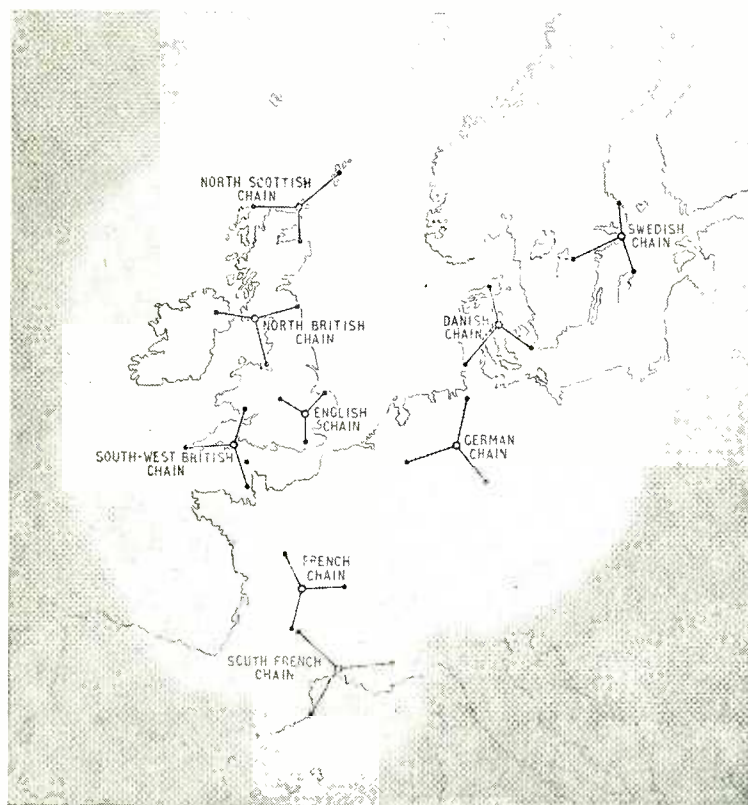

PLANS have been made to build three new chains of Decca Navigator stations in Europe—in Sweden, southern France and northern Scotland—making a total of nine. When the new stations are completed some 2,000,000 square miles of Europe will be covered. As will be seen on this map, coverage will extend from Cape Finisterre to the Gulf of Bothnia and from Corsica to beyond the Faroes.

It is also announced that plans are being made for the first two chains of permanent stations to be erected outside Europe. They will cover the Bombay and Calcutta areas of India. Temporary low-power chains have been set up overseas for survey purposes; one of the latest being for the Japanese Hydrographic Department.

Since the first Decca chain in south-east England was opened in July, 1946, over 2,600 naval and merchant ships have been fitted with the Decca Navigator. An increasing number of civil aircraft are also using it, and a new receiver, the Mark 10, designed especially for aircraft, is being produced. It will cover seventeen different chain frequencies and provide automatic lane and zone identification.

LETTERS TO THE EDITOR

The Editor does not necessarily endorse the opinions expressed by his correspondents

Spurious Radiations from Wrotham

IN his article in your July issue J. R. Brinkley drew general conclusions on the co-siting of f.m. transmitters from observations made on the performance of the transmitters at Wrotham as they are at present installed. The arguments against co-siting of television transmitters are of course irrelevant when applied to f.m. transmitters, and "co-siting" is perhaps a misleading term to apply to the practice of feeding one aerial system with the output from three transmitters.

Mr. Brinkley is correct in pointing out that adequate steps must be taken to reduce coupling between transmitters, and he is also right in his statement that at the present time the attenuation of the filters now installed at Wrotham is insufficient. But, because of the severe interference on the medium-wave band the B.B.C. decided, in agreement with the Post Office and the radio industry, to bring Wrotham into regular service before the second half of the Home Service transmitter and the aerial combining units for the three transmitters were in their final form. In this way a v.h.f. service was made available at the earliest possible moment to listeners in London and South-East England. The temporary filters at present in use will be replaced by the final filters within the next few weeks. When this has been done the intermodulation products to which Mr. Brinkley refers, and of which we are naturally aware, will become negligible.

E. L. E. PAWLEY

Head of Engineering Services Group, B.B.C.

F.M. Receiver Design

WE cannot agree with J. K. Carter (correspondence in July issue) who rebukes us for using the ratio detector in our f.m. tuner described in the April and May, 1955, issues. The decision to use this in preference to the Foster-Seeley discriminator was made after considerable thought and the saving of one valve is only one of the factors which influenced us. A more important consideration is that the low distortion of the Foster-Seeley circuit can be obtained only by critical adjustment of the coupling between primary and secondary windings of the discriminator transformer. To make this adjustment requires equipment unlikely to be possessed by the amateur constructor. The linearity of the ratio detector is less dependent on circuit adjustment; moreover there is less inter-station noise than with the Foster-Seeley type.

Mr. Carter accuses us of being illogical but he conveniently overlooks the other sources of distortion in the complete f.m. chain and in particular the chief offender; namely, the moving-coil loudspeaker. "Or," to use his own words, "is there some mystic reason why $n\%$ distortion in the loudspeaker doesn't matter but $n\%$ cent in the output stage does?"

S. W. AMOS, G. G. JOHNSTONE.

Design for a Pre-amplifier

D. H. W. BUSBY, on p. 328 of his article in your July issue, says that a capacitance of 400pF could be placed across the output with the gain control fully advanced, with negligible loss of output at 15 kc/s.

This may well be so, but if the gain control is turned down to half-way, the reactance of the capacitor would appear across 50kΩ and would be fed from a source impedance of at least 50kΩ. In this case the response would be down by at least an extra 3.5 dB at 15 kc/s. In addition, the amount of high-frequency cut introduced would vary with gain control setting, being greatest with the slider electrically at centre, and would become progressively less on either side of this position.

London, S.E.26.

W. C. R. WITHERS.

The designer of the pre-amplifier writes.—Mr. Withers is quite correct. The amount of high frequency cut will

indeed vary with the gain control setting. If the loss due to the interconnecting cable is not to exceed 1dB at 15 kc/s for any setting, the corresponding permissible value of capacity is approximately 150 pF. This will normally correspond to at least 7-8ft of cable, which, for most purposes, will be found adequate.

D. H. W. BUSBY.

Damping Factor: A New Approach

AS the one originally responsible for introducing the term "damping factor"* the writer feels some responsibility for finding an alternative form now that we are so deeply in the morass. The term had many shortcomings but it could, at least, be used safely so long as it was always finite and positive. The commercial release of amplifiers with negative damping factors has been very confusing to engineers, to say nothing of the general public. For an increase of 22% in total circuit damping, the "damping factor" increases from 10 to infinity, then returns back from -infinity to -10. All these extraordinary changes in the damping factor would lead one to believe that something important was happening. In reality nothing has happened except a slight and steady increase in the total damping. The tricks played by the so-called damping factor are due merely to an unfortunate choice of definition. With this definition, instability occurs when the damping factor ≤ -1 .

The total circuit damping is a function of the total circuit resistance, that is, the algebraic sum of the voice coil resistance (always positive) and the amplifier output resistance (positive or negative). I therefore put forward the following as a much more satisfactory and logical substitute for damping factor:

$$\text{Damping ratio} = \frac{R_L}{R_L + R_O}$$

Where

R_L = load resistance

R_O = output resistance of amplifier

and where both R_L and R_O are referred to the same side of the transformer.

The following table is for $R_L = 15$ ohms and is purely as an example:

R_O ohms	$R_L + R_O$ ohms	Damping factor $= R_L/R_O$	Damping ratio $= R_L/(R_L + R_O)$
+75	+90	+0.2	0.167
+3	+18	+5	0.83
+1.5	+16.5	+10	0.91
+0.15	+15.15	+100	0.97
0	+15.0	∞	1.0
-0.15	+14.85	-100	1.01
-1.5	+13.5	-10	1.11
-5.0	+10.0	-3	1.5
-12.0	+3.0	-1.25	5.0
-13.6	+1.4	-1.1	10.7
-14.3	+0.7	-1.05	21.4
-15.0	0	-1.0	∞

on verge of instability

It will be seen that the proposed damping ratio is positive and finite so long as instability does not occur. It is also proportional to the actual damping in the circuit. It appears to be the only available function with all the desired qualities.

F. LANGFORD-SMITH

Amalgamated Wireless Valve Company,
Sydney, N.S.W., Australia.

* Langford-Smith, F., "Radiotron Designer's Handbook", 3rd ed. 1940.

Band II F.M. Tuner Unit

Design Suitable for Use With a Wide Range of A.F. Amplifiers

ALTHOUGH the tuner circuit described in the following pages was designed primarily for use with the Mullard 5-valve 10-watt amplifier circuit¹, or with the 20-watt circuit using EL34s², it is suitable for use with a wide range of amplifiers. The frequency range covers the whole of Band II (87.5-100 Mc/s), and while the circuit design chosen incorporates some of the more modern developments applicable to this type of reception, the construction is kept free from complication. The power supply would normally be taken from the main audio amplifier.

Circuit Description.—A complete circuit of the tuner unit is given in Fig. 1. The r.f. stage is a conventional pentode amplifier circuit, using a Mullard EF85. The associated aerial circuit is pre-tuned to the centre of the Band II range. In the anode circuit is an r.f. choke (L_3), with the parallel-fed r.f. tuned circuit (L_4, C_9, C_{10}, C_{11}), of which C_{10} forms one section of the two-gang tuning capacitor. The r.f. voltage, taken from a tap on L_4 , is fed into the grid circuit of a Mullard EF80 operating as a self-oscillating additive mixer. The oscillator section of the mixer is basically of the tuned-anode type, with a tuned circuit consisting of L_6, C_{12}, C_{13} and C_{14} (C_{13} forming the second section of the tuning gang.) The intermediate frequency developed by the mixer valve is fed to two conventional i.f. stages using Mullard EF41s, at an intermediate frequency of 10.7 Mc/s. In the second i.f. stage the EF41 operates as a partial limiter valve at high signal levels, and the bias developed across its associated grid circuit capacitor C_{32} is fed back to the first i.f. valve and to the r.f. valve. The final i.f. stage drives a ratio detector circuit containing a Mullard double

diode, type EB91. Audio-frequency voltages developed in the detector circuit are taken through a 50-microsecond de-emphasis network consisting of R_{16} and C_{45} , and thence to the a.f. output socket for feeding to the audio amplifier.

Aerial Circuit and R.F. Stage.—The aerial circuit has been designed to be matched to a 75- Ω balanced feeder line, thus permitting a simple connection from a conventional type of dipole aerial. In cases where the feeder line of this type is unshielded, L_1 may be centre-tapped to earth so that any noise voltages picked up in the feeder itself are reduced. Dust core tuning is employed, and the resonant frequency of the grid tuned circuit is arranged to be 94 Mc/s. The total tuning capacitance in the grid circuit is of the order of 18pF, of which C_2 forms 5pF and the remainder is formed by the valve input capacitance, plus stray capacitance. The input damping of the valve amounts to 3,800 Ω , giving an effective secondary circuit impedance of the order of 1,600 Ω (without the aerial circuit connected). When attached to an appropriate feeder cable, the aerial circuit bandwidth is 10.8 Mc/s for 3 dB down on 94 Mc/s and the measured aerial gain is 14 dB.

C_{10} which has a maximum capacitance of 27pF tunes the r.f. circuit, and the series capacitor C_9 and trimmer C_{11} are added to track the r.f. circuit correctly to the oscillator circuit. Thus the equivalent capacitance swing is limited to approximately 8pF, and, in addition to the lumped capacitor constants, a further 12pF and 4pF are added to the circuits in the form of the r.f. valve output capacitance plus strays and the equivalent input capacitance of the mixer reflected into the tuned circuit, respectively. To assist further in obtaining correct tracking over

Fig. 1. Complete circuit diagram. Further details of component specification are given at the end of the article.

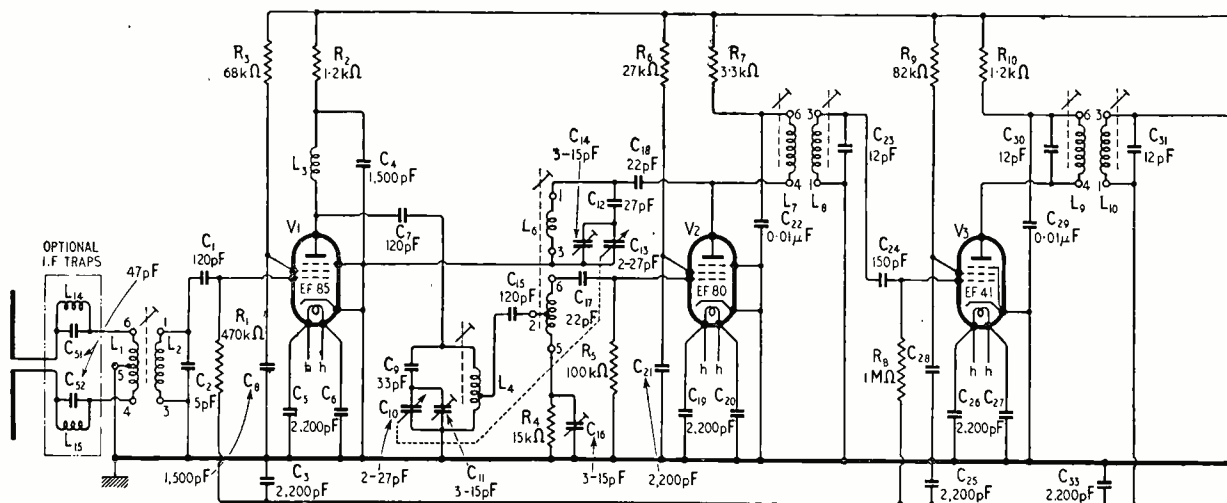

By
L. HAMPSON, B.Sc.*

the whole of the band, L_4 is tapped by means of C_{15} , so that the loaded Q factor of the r.f. circuit is comparatively high. The average value is 75, and a mean bandwidth of 1.3 Mc/s for 3 dB attenuation is maintained over the whole tuning coverage, for any point in the band. Therefore, with an equivalent load impedance of the order of $4.5k\Omega$ at 94 Mc/s for the r.f. tuned circuit, a theoretical gain of 43 dB is obtained for the r.f. stage (including the aerial circuit). Under the circuit conditions shown the EF85 operates at a mutual conductance in the region of $9.5mA/V$. Measurement of the stage gain showed it to be only slightly less than calculated.

Mixer Circuit.—The self-oscillating type of mixer adopted in this circuit, has proved highly popular in countries where f.m. reception is well established. For successful operation the frequency difference between the developed intermediate frequency and the incoming signal frequency should be large. Fortunately this is generally so in f.m. receiver applications, where the intermediate frequency is usually about 10 Mc/s. As its name implies it is essentially an oscillator with provision for feeding in an r.f. signal, so that additive mixing occurs on

a common electrode (in this case the control grid of the EF80). The anode circuit contains an i.f. transformer which is tuned to the intermediate frequency developed.

The voltage gain of this single valve circuit is equivalent to that of a two-valve stage consisting of an oscillator and a separate mixer. At the same time the inherently low equivalent noise resistance obtainable with additive mixing is retained. In addition the use of a single valve makes the circuit economically more attractive.

In a mixer of this type, it is generally essential to have some form of "isolation" between the r.f. tuned circuit and the oscillator circuit of the mixer to prevent interaction and pulling of the oscillator section. This is achieved by operating the oscillator in a bridge circuit, the equivalent circuit of which is shown in Fig. 2. It will be seen then, that for the bridge circuit to be in balance, the relation,

$$C_{16} = \frac{C_{in} \times L_{5A}}{L_{5B}}$$

must hold. When this condition has been achieved there will be minimum interaction between the two relevant circuits. An obvious added advantage of this bridge connection is that when in balance, there will be minimum oscillator voltage at the r.f. input point. This is important in order

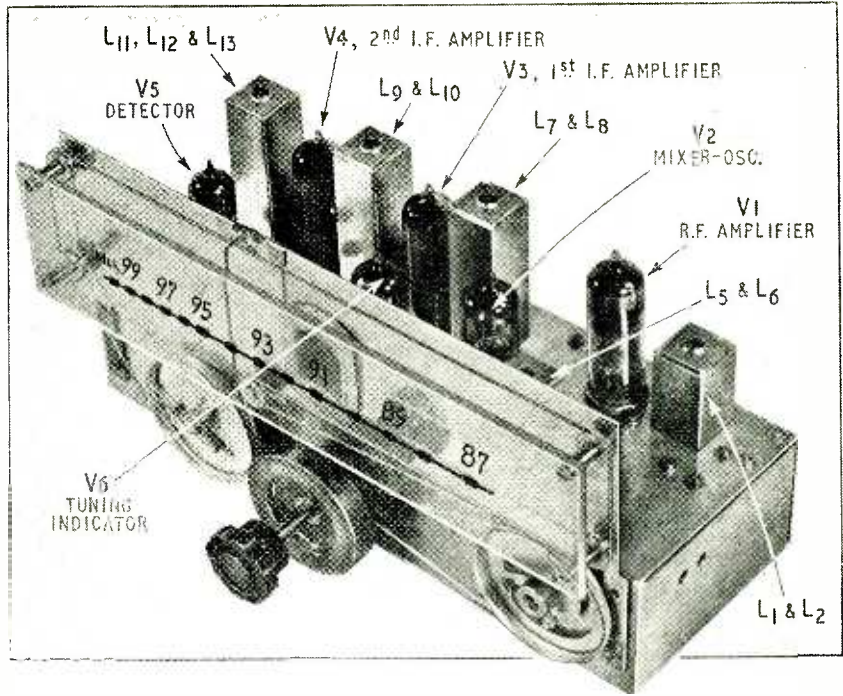

Layout of components on the top of the chassis.

* Mullard Valve Measurement and Application Laboratory

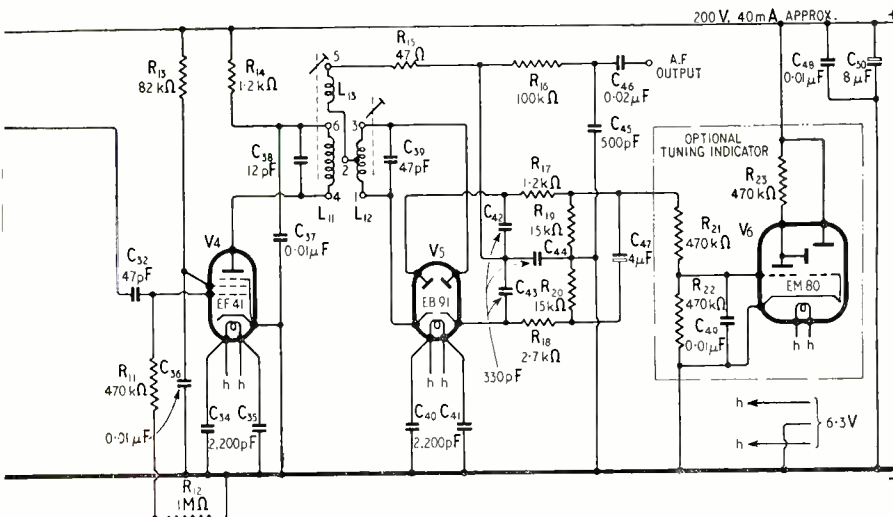

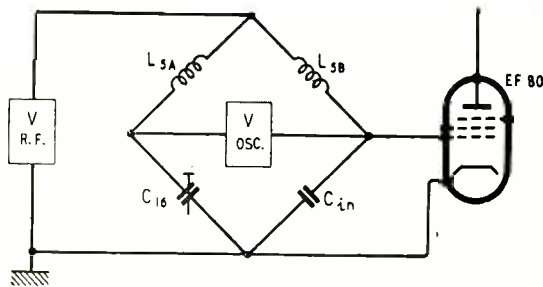

Fig. 2. Equivalent bridge circuit of oscillator section of mixer valve. C_{in} represents the valve input capacitance.

to keep the oscillator voltage at the aerial terminals as low as possible. In this circuit, it is possible to reduce the oscillator voltage to an average value of 100mV at the r.f. input point.

The oscillator circuit is operated at a frequency higher than the signal frequency, i.e. at approximately 97 to 111 Mc/s. As with the r.f. circuit, a series capacitor C_{12} and a parallel trimmer C_{14} are included for tracking purposes, giving an effective swing of the tuning capacitor C_{13} of approximately 7 pF. To keep the oscillator circuit as stable as possible the total capacitance associated with the tuned circuit has been made as large as possible, consistent with obtaining sufficient oscillator drive for the mixer valve. Also the cathode of the mixer valve is directly earthed in order to avoid capacitive hum modulation.

The blocking capacitor C_{18} also forms the tuning capacitance for L_7 , since L_6 is effectively a short-circuit at the intermediate frequency. Similarly L_7 forms an r.f. choke at the oscillator frequency. It will be seen then that the effective lumped tuning capacitance across L_7 is equivalent to:

$$\frac{C_{22} \times C_{18}}{C_{22} + C_{18}}$$

and the voltage tap down in the i.f. transformer is equal to

$$\frac{C_{22}}{C_{out} + C_{18} + C_{22}}$$

where C_{out} is the valve output capacitance.

However, as the value of C_{22} is so much higher than C_{18} , the loss in gain of the mixer is negligible.

In order to ensure that the mixer valve operates on the optimum point of the conversion conductance curve, it is recommended that the oscillator grid

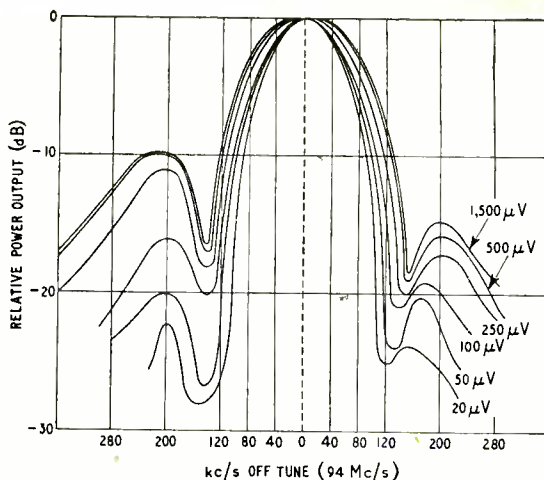

Fig. 3. Tuning characteristics for various input signal levels at the aerial terminals, with a frequency deviation of 22.5 kc/s.

current should not fall below a level of $35\mu\text{A}$ in any part of the band. It will be found in operation that the oscillator grid current will not vary by more than approximately $\pm 10\%$ of the mean value over the tuning range.

A conversion conductance of 2.5 mA/V is obtainable with the EF80. Therefore, with the i.f. transformer used, the mixer gain from the tap point of L_5 to the signal grid of the first i.f. valve will be 32 dB. Due to the tapping of L_4 , the effective gain of the r.f. stage is proportionately reduced to 34 dB. At 94 Mc/s the overall "front end" gain is of the order of 66 dB, measured from the aerial terminal to the control grid of the first i.f. valve.

I.F. Stages.—The design of i.f. stages for f.m. receivers presents a considerable number of conflicting problems. Very briefly summarized they are:—

- (i) There should be adequate transmission of the significant side currents.
- (ii) A good measure of adjacent channel selectivity is required.
- (iii) There should be a reasonably linear phase/frequency characteristic in the transformers.
- (iv) A certain allowance in the bandwidth should be made for small random drift in the oscillator.
- (v) The uses of comparatively large values of

overcoupling to give a wider bandwidth can produce a high degree of amplitude modulation on the carrier wave, and may give rise to ringing with impulsive interference.

It was decided that for the two i.f. transformers used in this tuner, a coupling factor K of design centre 1.2, would be most suitable to meet a compromise for the above requirements, provided the average loaded Q factor of the tuned circuits in the i.f. transformers is in the region of 60 to 70. ($K = k\sqrt{Q_p Q_s}$, where k is the coupling coefficient and Q_p and Q_s refer to primary and secondary windings.)

TABLE I

	1st I.F. Transformer		2nd I.F. Transformer		Ratio Detector	
	Prim. L_7	Sec. L_8	Prim. L_9	Sec. L_{10}	Prim. L_{11}	Sec. L_{12}
Fixed tuning capacitance (pF)	22	12	12	12	12	47
Valve capacitance + strays (pF)	8	10	10	10	10	—
Loaded Q in circuit	55	55	68	60	35	26
Coupling factor	1.25		1.25		0.65	
$K = k\sqrt{Q_p Q_s}$	15.8		21.2		—	
Transfer impedance (k Ω)	—		—		16.8	
Input impedance (k Ω)	—		—		—	

In addition to the above requirements it is essential that feedback through the anode-to-grid capacitance of the valve, should be kept small. This usually calls for a strict limit on the maximum usable transfer impedance obtained in an i.f. transformer when applied with any particular valve type. With the EF41, the recommended maximum design centre transfer impedance for the i.f. transformer is 21 k Ω at 10.7 Mc/s, taking into account the added effective anode-to-grid capacitance in the valveholder, and assuming identical impedances in grid and anode circuits.

Table 1 gives a summarized performance of the transformers used in this tuner. All the values quoted were measured in circuit.

The two EF41 valves operate with a mutual conductance of 2.3 mA/V, and from the relevant impedances given in Table 1, it can be calculated that the total i.f. gain, from the control grid of V3 to the anode of V4 will be 64 dB. Actual measurement showed a slightly lower value.

Measurement of the overall bandwidth of the first and second i.f. transformers gave approximately 210 kc/s for 3 dB, and 600 kc/s for 20 dB, attenuation. The response curve is flat for approximately 70 kc/s, with a slight dip at the centre frequency.

The coils for the i.f. transformers are wound on common formers, details of which are given later in the Appendix. An inherent drawback in this method of construction is that movement of the dust cores can materially alter the coupling factor if the primary and secondary windings are, by necessity, brought too close together. This is to some extent eliminated in the design presented here, by separating about 25% of the total windings on the coils, so as to form small coupling coils at the earthy end of each winding. Thus the dust cores are kept at least 15 mm distant in the main body of the windings and little measurable

difference in the coupling factor is obtained when the transformers are tuned to ± 1 Mc/s of the correct working centre frequency. The unloaded Q factors of the coils are about 90, with the exception of L₁₂ which is approximately 85.

As previously mentioned, on high signal levels V4 is driven into appreciable grid current, and the derived bias voltage developed across R₁₁ and R₁₂ is used as semi-automatic gain control. Positive peaks of amplitude modulation appearing on the carrier wave are therefore clipped in the grid circuit. With V4 primarily designed as an amplifier, a very high input voltage to the grid is required before saturation occurs. Therefore with only partial limiting occurring, the valve does not deal completely with positive—or negative-going amplitude variations of the carrier. For similar reasons partial limiting may give only restricted elimination of impulsive interference. The time constant of the grid circuit of V4 has been set at 25 microseconds to deal with the upper frequency limits of amplitude variations in the carrier. The small changes in the input capacitance of V4 due to limiter action in the grid circuit and of V3 due to the restricted range of applied bias voltage were not found to introduce any serious deterioration in the required performance of the band-pass filters. Further, harmonics produced by limiter action do not usually cause trouble, as they will be tuned out in the anode circuit of V4.

Ratio Detector—A balanced ratio detector circuit incorporating a double diode (V5) is used in this tuner. To give optimum a.m. rejection under working conditions, R₁₇ should be adjusted for each individual circuit and is specified here as a nominal value.

The value of a.m. rejection measured in the circuit was 46 dB at the centre frequency (10.7 Mc/s) for 30V r.m.s. of i.f. voltage at the anode of V4, falling to

View of underside of chassis with some of the more prominent components identified.

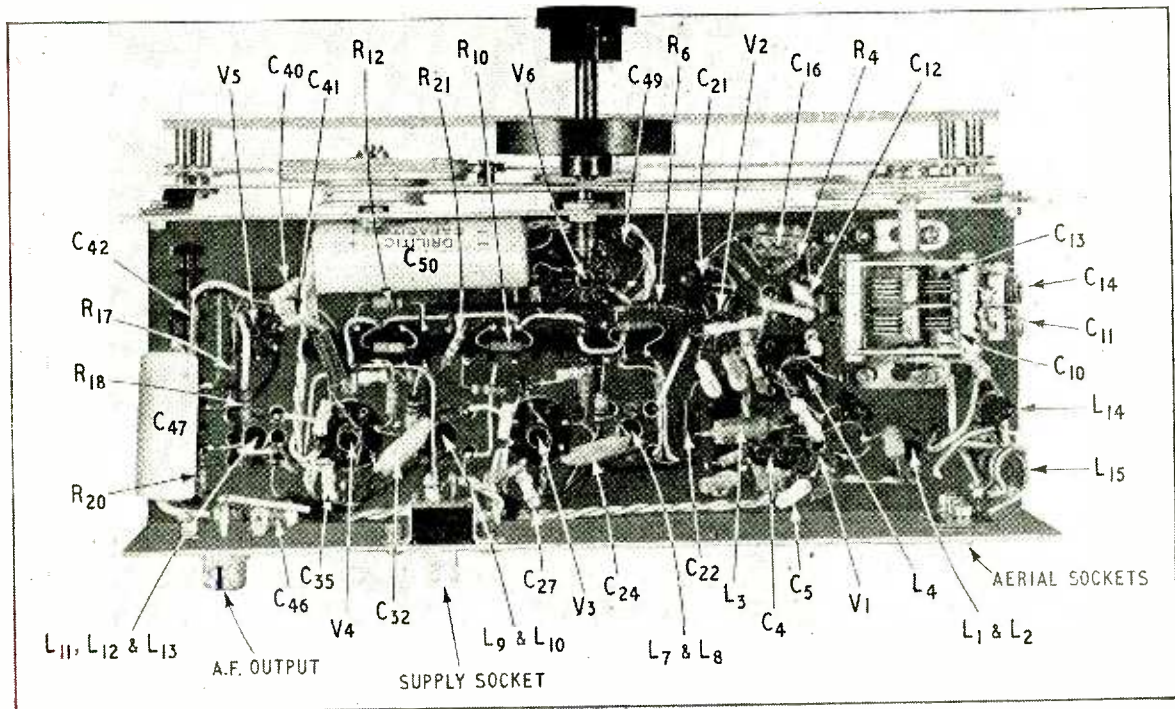

28 dB for ± 75 kc/s detuning of the signal. Similarly for 20 and 10V r.m.s. of i.f. signal, the values were 34 and 26 dB respectively, with corresponding values of 22 and 17 dB for ± 75 kc/s detuning. These figures include limiter action produced by V4. The peak separation of the "S" shaped detector curve is 320 kc/s.

Measurement of the tuning characteristic is advantageous in a prototype f.m. receiver, in order to examine the side responses which are inherent in most f.m. detector systems. These are shown in Fig. 3, where the tuning characteristic of the unit is plotted for various values of input signal.

These characteristics can be regarded as typical for a receiver equipped with a ratio detector circuit. The side responses are shown at about ± 200 kc/s from the centre frequency. To a certain extent these side responses are controlled by the selectivity characteristic of the preceding i.f. stages, and also by the action of a.g.c. In general, receivers designed with a rounded-top overall i.f. response curve, and a comparatively wide peak separation in the detector system help to reduce side responses and produce a peak in the audio output, when the signal is in tune. It may be noted in passing that, with the Foster-Seeley detector circuit and limiter valves, the side responses may be of a higher value than the main signal response. Although the side responses show a comparatively high value in the graph at the larger signal levels, they are in fact hardly noticeable when tuning through the signal.

The audio output from the detector is taken through the 50-microsecond de-emphasis network R_{16} and C_{15} , and coupling capacitor C_{16} to the a.f. output socket. When the output from the tuner is fed to an audio amplifier it is recommended that the amplifier input impedance be not less than 500 k Ω . For use with the pre-amplifier³ designed for use with the 20-watt EL34 circuit² and with other pre-amplifiers of similar input impedance and sensitivity it is recommended that a correction circuit (Fig. 4) be used to obtain the required input impedance and attenuation.

Tuning Indicator.—An optional tuning indicator using a Mullard EM80 is fitted. The bias voltage for this valve is derived from the ratio detector circuit.

Overall performance.—The total gain of the prototype tuner from the aerial terminals to the anode of V4 was approximately 130 dB for a small signal at 94 Mc/s. When coupled to a Mullard 5-valve 10-watt amplifier, the average sensitivity over the band for 50 mW output was 1.2 μ V with a signal of 22.5 kc/s deviation. The average input signal over the band for 500 mV audio output is approximately 12 to 15 μ V.

Oscillator radiation.—The average oscillator voltage measured at the aerial terminals was 350 μ V for the fundamental oscillator frequency and 75 μ V for the 2nd harmonic. The average radiated field strengths over the band are 40 μ V per metre and <15 μ V per metre respectively at a distance of 10 metres from the measuring aerial.

Constructional details.—The accompanying photographs show the main layout of the tuner. A chassis of 16 s.w.g. aluminium, dimensions 10 in \times 3 $\frac{1}{2}$ in, with 2 in depth, is used. With the exception of the valves, i.f. transformers, aerial and oscillator coils and scale assembly, all components are mounted underneath the chassis.

A balanced heater circuit is used. This enables the tuner to be connected to the centre-tapped heater supply of either of the amplifier circuits previously

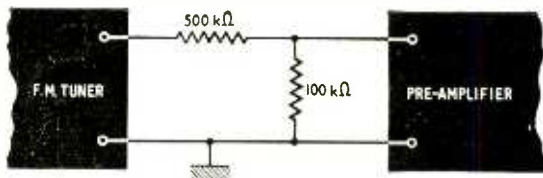

Fig. 4. Simple attenuator recommended for use with amplifiers of high sensitivity and input impedance less than 500k Ω .

referred to^{1,2}. Adequate r.f. decoupling of the heater supply lead is essential, in particular to prevent harmonics from the detector from reaching the earlier stages. The ninth harmonic of the i.f. can be particularly troublesome, as this falls in the centre of the tuning range. Strict attention should be paid to the general decoupling of the valve electrodes, and to the tuned circuits. The relevant decoupling capacitors, should be returned to, or very near to, the cathode-to-chassis connection of the valve concerned, with the shortest possible leads. It is also essential that C_{16} should have a short connection to chassis.

The tuner requires an h.t. supply of 200 V at approximately 37 to 40 mA and a heater supply of 6.3 V at 1.6 A. Where the h.t. supply is obtained from an amplifier and exceeds 200 V the necessary dropping resistance should be included in the amplifier itself.

To minimize oscillator drift during the warming up period, C_{12} should be of the negative temperature coefficient type, a component of temperature coefficient 750 parts per million being suitable. This will help to keep the long term oscillator drift to a minimum. In the prototype, C_{14} and C_{16} were formed of a 6.8pF capacitor in parallel with a 1.25-10pF trimmer to make up the nominal total. The tap on the r.f. coil is arranged to be at 0.4 of the total number of turns, counting from the earthy end. Optional i.f. traps L_{14} , C_{51} and L_{15} , C_{52} have been incorporated in the aerial circuit for use where a high degree of i.f. rejection is considered essential. In most cases they may be found unnecessary.

Neatness in wiring is essential. In particular, in the i.f. stages, components should not be piled over the top of the valveholder as this may lead to an increase of effective anode-to-grid capacitance.

Alignment.—The correct alignment of an f.m. receiver calls for the use of some expensive equipment, but good results can be obtained by using only an a.m. signal generator, covering Band II (87.5-100 Mc/s) and the intermediate frequency of the tuner (10.7 Mc/s). As the first two i.f. transformers are overcoupled, it is essential to damp the transformers whilst they are being tuned, otherwise unsymmetrical response curves may result. A resistor of about 5 k Ω is suitable for this purpose and it should be placed across the grid circuit tuned winding, when the anode circuit is being tuned, and vice versa. The resistor can be temporarily held on with a touch of solder.

Connect the signal generator output (10.7 Mc/s) to the control grid of V4 and tune L_{11} for maximum deflection either in the tuning indicator or on a high resistance voltmeter (20 k Ω /V, 10 V scale) across C_{17} . Transfer the generator in turn to the grid of V3, and the centre-tap point of L_5 . Tune L_9 , L_{10} and L_7 and L_8 respectively for maximum deflection, using the damping resistor for the coils as before.

To eliminate considerable trial and error in the alignment of the r.f. and oscillator circuit, some approximate values of the correct trimmer settings

are given. C_{16} can be set initially at about 10 pF, and C_{14} to 12 pF, with the dust core of L_6 tuning in the base end of the coil away from L_5 . C_{11} is set at approximately 5 pF. The bridge circuit may be balanced by connecting an r.f. valve voltmeter from the tap point of L_4 to earth, and adjusting C_{16} for minimum oscillator voltage. While this operation is being done, the main tuning gang should be set with the vanes about half-way between minimum and maximum capacitance. If an r.f. valve voltmeter is not available, a rough and ready, but quite effective method of obtaining balance is to short-circuit the tap on L_4 to earth and observe the change in grid current through R_5 (on 50 μ A scale). C_{16} is then adjusted until the change in grid current on short-circuiting L_4 to earth is a minimum.

With the signal generator connected at the aerial terminals and the tuning gang at maximum capacitance apply a signal of 87 Mc/s, and tune L_6 dust core so that a maximum deflection is indicated in the tuning indicator or voltmeter. Re-tune the signal generator to 100 Mc/s and adjust C_{14} for optimum output with the tuning gang at minimum capacitance. These settings may need to be checked a number of times to give the correct frequency range for the oscillator.

Re-set the signal generator to 91 Mc/s and adjust L_1 dust core for maximum output. Adjust C_{11} for

maximum output at 98 Mc/s and finally set L_2 dust core for maximum output at 93-94 Mc/s. The dust core of the aerial coil should also be at the base end of the former. To align the i.f. traps apply a comparatively large input signal of 10.7 Mc/s to the aerial terminals, and tune L_{14} and L_{15} for minimum indicated output. With the signal generator connected again to V4 grid and with the signal of 10.7 Mc/s adjust L_{12} core, for zero d.c. voltage across C_{44} . This ensures that the ratio detector circuit is reasonably well balanced.

REFERENCES

- "Mullard 5-valve 10-watt High Quality Amplifier Circuit," published by Mullard Ltd. Also briefly described in: "Inexpensive 10-watt Amplifier," *Wireless World*, August 1954.
- "A High-quality Ten-Watt Audio Amplifier," by D. H. W. Busby and W. A. Ferguson. *Mullard Technical Communications*. Vol. 1, No. 9. Nov., 1954.
- "Design for a 20-watt High-Quality Amplifier, 2—Constructional Details and Performance," by W. A. Ferguson. *Wireless World*, June 1955.
- "Design for a Pre-amplifier, for use with a 20-watt High-quality Amplifier," by D. H. W. Busby. *Wireless World*, July 1955.

(Appendix—Coil Winding Data—on next page)

COMPONENTS LIST FOR F.M. TUNER

Capacitors

C_1 120 pF $\pm 20\%$ (C)	C_{16} 120 pF $\pm 20\%$ (C)	C_{33} } 2,200 pF $\pm 20\%$
C_2 5 pF $\pm 10\%$ (C or SM)	C_{16} 3-15 pF (nominal)	C_{34} }
C_3 2,200 pF $\pm 20\%$ (C)	C_{17} 22 pF $\pm 10\%$ (C)	C_{35} }
C_4 1,500 pF $\pm 20\%$ (C)	C_{18} 22 pF $\pm 5\%$ (C)	C_6 } 0.01 μ F Met. paper
C_5 } 2,200 pF $\pm 20\%$ (C)	C_{19} } 2,200 pF $\pm 20\%$ (C)	C_{37} } 12 pF $\pm 5\%$ (C or SM)
C_6 }	C_{20} }	C_{38} } 47 pF $\pm 5\%$ (C or SM)
C_7 120 pF $\pm 20\%$	C_{21} 2,200 pF $\pm 20\%$ (C)	C_{40} } 2,200 pF $\pm 20\%$ (C)
C_8 1,500 pF $\pm 20\%$	C_{22} 0.01 μ F Met. paper	C_{14} }
C_9 33 pF $\pm 5\%$	C_{23} 12 pF $\pm 5\%$	C_{42} }
C_{10} } 2/27 pF Two-gang variable	C_{24} 150 pF $\pm 20\%$	C_{43} } 330 pF $\pm 5\%$
C_{13} } (Jackson U101 S-S)	C_{25} }	C_{44} }
C_{11} 3-15 pF (nominal) (composed	C_{26} } 2,200 pF $\pm 20\%$ (C)	C_{45} } 500 pF (SM) $\pm 10\%$
of 1.25 —10pF trimmer,	C_{27} }	C_{46} } 0.02 μ F (T.C.C. "Metalmite.")
Wingrove & Rogers, Type C32.01	C_{28} } 0.01 μ F Met. paper	C_{47} } 4 μ F 150 V.W. electrolytic
+ 6.8 pF, SM)	C_{29} }	C_{48} } 0.01 μ F Met. paper
C_{12} 27 pF $\pm 5\%$ (optional n.t.c. 750	C_{30} } 12 pF $\pm 5\%$ (C or SM)	C_{49} } (for optional tuning indicator)
parts per million)	C_{31} }	C_{50} } 8 μ F 350 V.W. electrolytic
C_{14} 3-15 pF (nominal)	C_{32} 47 pF $\pm 20\%$	C_{51} } 47 pF $\pm 5\%$ (C) (for optional

C — Ceramic. SM — Silvered mica

Resistors (all resistors $\frac{1}{2}$ watt Dubilier "BTS" type)

R_1 470k Ω $\pm 20\%$	R_{13} 82k Ω $\pm 10\%$
R_2 1,200 Ω $\pm 20\%$	R_{14} 1,200 Ω $\pm 20\%$
R_3 68k Ω $\pm 10\%$	R_{15} 47 Ω $\pm 10\%$
R_4 15k Ω $\pm 10\%$	R_{16} 100k Ω $\pm 10\%$
R_5 100k Ω $\pm 10\%$	R_{17} 1,200 Ω \pm nominal $\pm 5\%$
R_6 27k Ω $\pm 10\%$	R_{18} 2,700 Ω $\pm 5\%$
R_7 3,300 Ω $\pm 20\%$	R_{19} }
R_8 1.0M Ω $\pm 20\%$	R_{20} } 15k Ω $\pm 5\%$
R_9 82k Ω $\pm 10\%$	R_{21} }
R_{10} 1,200 Ω $\pm 20\%$	R_{22} } 470k Ω $\pm 20\%$ } (For optional
R_{11} 470k Ω $\pm 20\%$	R_{23} } 470k Ω $\pm 20\%$ } (For optional
R_{12} 1.0M Ω $\pm 20\%$	

Other Components

Miniature tag strips—British Moulded Plastics Type A 5556
Stand-off insulators—Wingrove and Rogers. Type TS1-01/1.
Scale and drive assembly—Jackson, Type SL15.

Valves

V1	Mullard EF85
V2	Mullard EF80
V3, V4	Mullard EF41
V5	Mullard EB91
V6	Mullard EM80 (Optional tuning indicator)

Coils

Aerial transformer L_1, L_2	Denco 510/AE
R.F. choke L_3	Denco 510/RFC
R.F. coil L_4	Denco 510/RF
Oscillator coil L_5, L_6	Denco 510/OSC
1st i.f. coil L_7, L_8	Denco 510/IFT.1
2nd i.f. coil L_9, L_{10}	Denco 510/IFT.2
Ratio detector Transformer,	
L_{11}, L_{12}, L_{13}	Denco 510/RDT
I.F. traps L_{14}, L_{15}	Denco 510/IFF

APPENDIX—BAND II F.M. TUNER UNIT COIL WINDING DATA

I.F. TRANSFORMERS

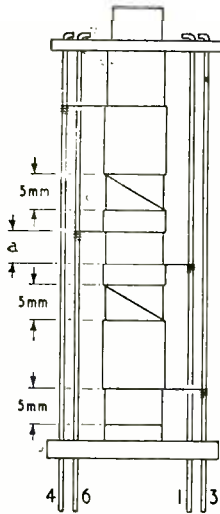

1st I.F. 2nd I.F.

L_{7A} L_{9A}
26 TURNS 33 TURNS

L_{7B} L_{9B}
10 TURNS 10 TURNS

L_{8B} L_{10B}
10 TURNS 10 TURNS

L_{8A} L_{10A}
33 TURNS 33 TURNS

a = 2.5mm 4.5mm

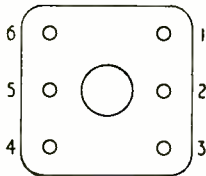

ALL COILS, EXCEPT L₁₂
WOUND WITH 35 s.w.g.
ENAMELLED D.S.C.

* TOLERANCE
± 0.25mm

RATIO DETECTOR TRANSFORMER

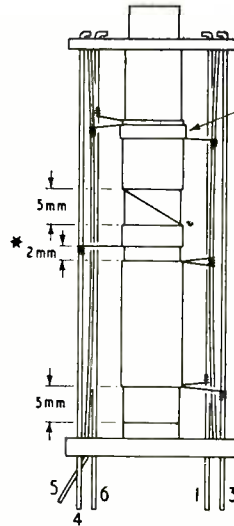

L₁₃
7 TURNS OVERWOUND ON L_{11A}
SEPARATED FROM L_{11A} BY 2 TURNS
OF 0.001 in TRANSFORMER PAPER

L_{11A}
31 TURNS

L_{11B}
10 TURNS

L₁₂
14 + 14 TURNS
BIFILAR WOUND
34 s.w.g. ENAM.

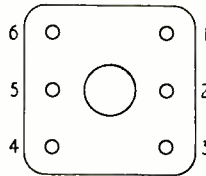

R.F. CHOKE

L₃
27 TURNS 30 s.w.g.
ENAM. D.S.C.

1/4" DIA.
POLYSTYRENE ROD

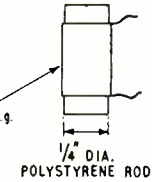

I.F. TRAPS L₁₄ & L₁₅

25 TURNS 38 s.w.g.
ENAM. D.S.C.

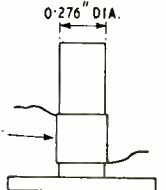

Formers: Aladdin PP No. 5937 (with screening can) or Neosid 5000B.

Dust Cores: Neosid Grade F 900. Length 16mm. Dia. 6mm. Pitch 1mm.

It is emphasized, that only the absolute minimum amount of sticky tape should be used to hold the i.f. transformer coils in position, otherwise the Q factor will be affected considerably or the self-capacitance of the coils will be increased.

Former: Neosid type 358/8BA.

AERIAL COIL

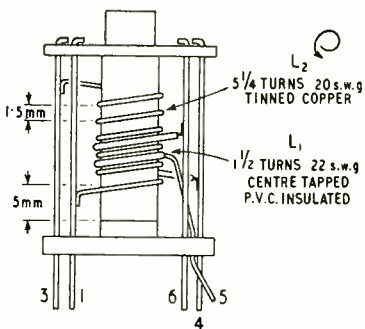

L₂
5 1/4 TURNS 20 s.w.g.
TINNED COPPER

L₁
1 1/2 TURNS 22 s.w.g.
CENTRE TAPPED
P.V.C. INSULATED

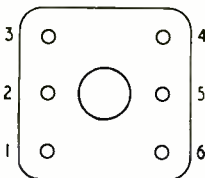

R.F. COIL

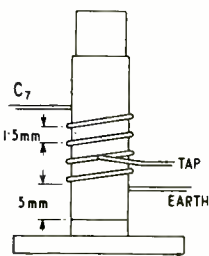

L₄
4 1/4 TURNS 20 s.w.g.
TINNED COPPER
TAPPED 0.4
OF TOTAL TURNS

Curled arrows refer to winding directions of coils.

OSCILLATOR COIL

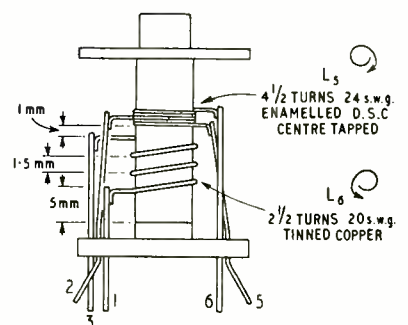

L₅
4 1/2 TURNS 24 s.w.g.
ENAMELLED D.S.C.
CENTRE TAPPED

L₆
2 1/2 TURNS 20 s.w.g.
TINNED COPPER

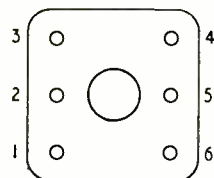

Formers: Aladdin PP No. 5938 (with screening cans) or Neosid 5000A.

Dust Cores: Neosid Grade I 901. Length 12.7mm. Dia. 6mm. Pitch 1mm.

New Navigational Aids

Radio and Radar Equipment at the Paris Air Show

THE twenty-first international aeronautical exhibition, held recently at Le Bourget aerodrome near Paris, demonstrated once again how very closely aviation progress and electronics are allied. Of the 180 exhibitors, representing ten different countries, some twenty were radio and radar manufacturers, and there was equipment from France, Great Britain, the U.S.A., Sweden, Italy and Germany on view.

In the field of radar, the French Compagnie Générale de Télégraphie sans Fil were giving interesting demonstrations of the remote presentation of radar pictures by a television system. The radar equipment was installed at Pontoise, north-west of Paris, and its images were transmitted by television link to the top of the Eiffel Tower, from which they were retransmitted to Le Bourget aerodrome. The system used depends largely on an analyser storage tube which the C.S.F. have developed and which is described as being a tube capable of storing signals in the form of a pattern of electrical charges deposited on a thin insulating target by a "writing" electron beam. The signals are "read" by a second beam, enabling them to be used to modulate a transmitter. The device is capable of storing the signals for periods ranging from microseconds to hours.

One half of the storage tube can be considered as the radar display system and has deflection coils synchronized with the aerial rotation. Instead of actually showing the image, however, it produces a charge pattern on the target plate in the middle of the tube. The electron beam in the other half of the tube, which has its own scanning system (usually a normal television scan), then discharges the target, the output of which is taken off at a collector electrode and used to modulate the television transmitter. The reading half of the tube is intensity modulated at 20 kc/s in order to avoid interference between the writing and reading scans. Thus on the writing side of the tube the scan can be radial, while on the reading side it can be orthogonal without inconvenience.

The television display equipment appeared to consist of domestic television receivers and they were relaying a radar picture of the Paris air traffic control zone. Until actual pictures are seen it is difficult to realize the full value of the storage tube for air operations, since the inherent tracking feature is so unusual to those who are used to seeing normal persistence radar screens. With the long "memory" the aircraft track is left on the screen from the moment it is first picked up until its goes out of range of the radar.

The chief advantages of the system are the inherent

automatic tracking already mentioned and the great improvement in contrast obtained in the television reproduction of the radar image, which can be made far better than the original picture on the radar screen and clearly readable in daylight.

Another unusual radar system, known as the "3D" (for "three-dimensional"), was exhibited by the French firm Radio Industrie. The equipment, which operates in the 10-cm band, provides range, bearing and height information from one aerial which moves only in the horizontal plane, the usual tilting movement of the reflector for height-finding being eliminated. This feature is obtained by the use of a system of scanning (known as a Robinson scan) in which the waveguide feed is moved mechanically so as to produce a change in the vertical direction of the beam from the aerial reflector. In practice the vertical beam can be varied over some 15 degrees and the scan rate is about 800 per minute. This form of height-finding is not new, of course, but in the Radio Industrie radar the disadvantages of previous equipments of this kind are claimed to have been overcome. The side-lobe suppression is stated to be

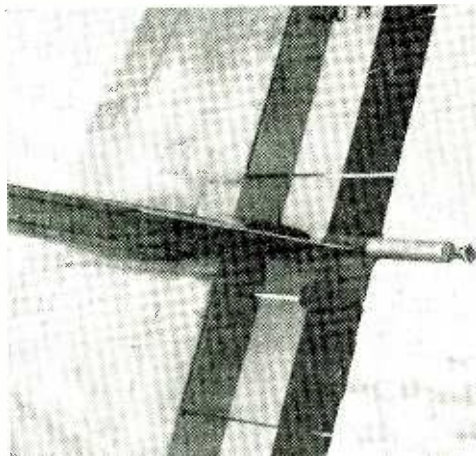

Fig. 1. Rear warning radar aerial in the form of a horn in the tail of a French "Ouragan" fighter aircraft.

greatly improved by the use of a specially shaped reflector and the beam width throughout the scan remains constant.

Coming now to airborne radar, an interesting feature of the cloud and collision warning radar shown by the Société Française Radioélectrique was the arrangement for preventing reduction in range by cloud "clutter" when the equipment is being used for collision warning. This takes the form of a series of probes which are introduced at an angle of 45° into the waveguide feeding the reflector. These are stated to make the polarization circular, under which conditions echos from clouds and rain are greatly reduced in amplitude. The equipment, which was shown installed in a full-sized model of an aircraft, uses a 5-in cathode-ray tube and a scanner reflector about 2ft across.

Also noted was a rear warning radar aerial in the tail unit of a French fighter aircraft (Fig 1).

Outstanding among the radio navigational aids on show was a new instrument landing system by the French company C.S.F. It has the advantage over previous systems of operating on a single frequency and of giving the facilities of azimuth, elevation and distance measurement to the pilot on dial-type instruments. As in other landing aids, overlapping radio beams with different modulation frequencies are used for azimuth and elevation measurement and an

interrogator-responder is used for the measurement of distance, the interrogation frequency being between 984 and 996 Mc/s.

The use of a single frequency only is made possible by a form of time-sharing pulse transmission. The cycle of transmission is for an azimuth left-hand beam first, followed by an elevation lower beam and then an azimuth right-hand beam and finally an elevation upper beam. The pulse for each of these transmissions lasts 1/65 second and each is separated by an interval of 1/360 second. There is then an interval of 1/40 second, during which time the transmitter can send out the response signals to the airborne interrogator, using the distance-measuring facility. The cycle of operations is controlled by a rotary switch revolving 600 times per minute (Fig. 2) which feeds into waveguides and thence to the four aeriels. Two of the aeriels are for laying down the azimuth beams (known as the "localizer") and are placed upon either side of the runway. The other two are "cheese" aeriels providing the elevation beams (known as the "glide-path"), one radiating the upper and the other the lower beam to form a 2½° descent guidance path. The pulses sent out are modulated with a square wave of 20 kc/s for the left-hand "localizer" lobe and 24 kc/s for the right-hand lobe. For the "glide-path" the upper lobe modulation is 34 kc/s and that of the lower lobe 30 kc/s. The aerial for the distance measurement is a "cheese" with separate feeds for transmission and reception.

The airborne equipment consists of two small units and a power supply, together with a crossed-pointer "localizer" and "glide-path" indicator. Distance is indicated on an edge-scale instrument.

Signals can be received from the "localizer" transmitter at a distance of about 25 miles and the distance-measurement transmitter has a slightly shorter range. The "localizer" accuracy is to within ±½° at 1½ miles from the transmitter and the distance measuring facility has an accuracy to within 150yd up to 5 miles from the transmitter.

A new "talking beacon" made by the Swedish firm AB Gasaccumulator and intended mainly for fighter aircraft does not require the installation of any special receiver in the aircraft as it operates off the normal v.h.f. equipment on 100-150 Mc/s.

The beacon depends upon sharply defined beams for its correct operation and these are obtained from two aerial arrays mounted back to back with a screen between them (Fig. 3). This permits forward and backward beams to be radiated without mutual interference. When, for instance, the forward beam is pointing in a northerly direction a transmission by voice of the course to steer to reach it is made, while at the same moment, when the backward beam is pointing south, a voice transmission of the reciprocal bearing is also made from a second transmitter. There is a limitation to the number of voice announcements which can be made, determined by the frequency with which information is needed in practice, and this has been settled at a repetition rate of every 30 seconds when flying on a constant compass heading. At this speed the announcements are made every 20 degrees of beam rotation. Since the aeriels are relatively simple there are side lobes present which could give rise to false courses unless precautions were taken to prevent them. The side lobes are therefore masked by a third transmitter which is ten times more powerful than the voice transmitters and which feeds into an "H" type aerial

having a figure-of-eight polar diagram. This aerial is so placed that the wanted beams for the two bearings appear in the crevasses of the masking figure-of-eight polar diagram. Thus all of the side lobes are rendered inaudible by the modulation of the masking transmitter, which is synchronized in time with the voice announcements.

The "Narco Omnigator," made by the American National Aeronautical Corporation and exhibited by the French firm Air Tourist, was of considerable interest, being typical of American radio equipment technique for small aircraft. The instrument, which is compactly designed and only weighs 18lb, combines the functions of v.h.f. transmission on 8 channels, continuously tuned v.h.f. reception over the 108-127 Mc/s band, instrument landing system (ILS), v.h.f. aural range (VAR), v.h.f. omni-directional range

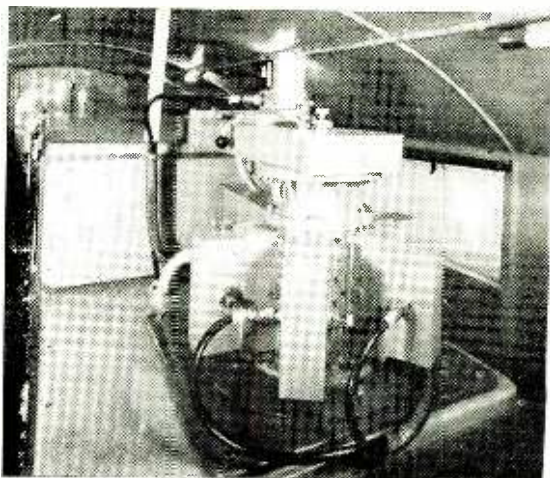
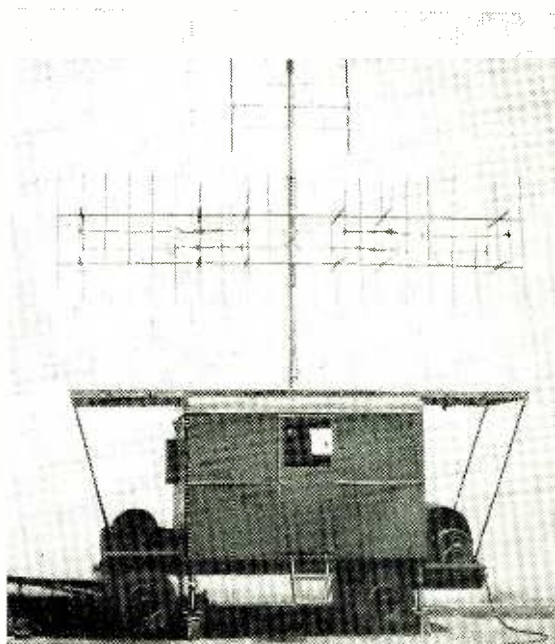

Fig. 2. Rotary switch used at the transmitter of the C.S.F. instrument landing system.

Fig. 3. Swedish "talking beacon" showing the masking aerial mounted above the main array.



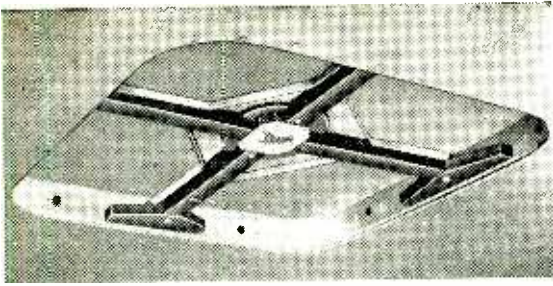

Fig. 4. Bendix radio compass with ferrite-rod aerial elements flush-mounted underneath an aircraft fuselage.

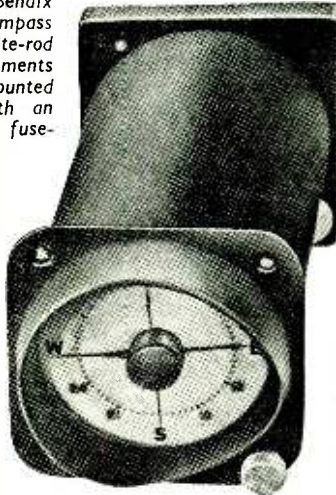

Fig. 5. Cathode-ray tube indicator used in the S.I.N.T.R.A. airborne radio compass.

(VOR) and "marker" reception. It is panel mounted and occupies a frontal area of only about $6\frac{1}{2}$ in \times $6\frac{1}{2}$ in.

Flight demonstrations of the latest Decca Navigator flight log computers* were given throughout the period of the show. These devices, which operate from signals provided by Decca Navigator airborne receivers, are very much lighter in weight than previous computers and effect a saving of some 40 lb when used in a complete installation. They are entirely electro-mechanical, using no valves, and are designed for operating speeds up to 700 knots. To permit operation at this very high speed, a special memory circuit is included which prevents interference from "lane identification" signal breaks causing loss of "lanes" and is similarly effective during short signal interruptions.

In air navigation nowadays most of the official procedures for approach and departure to and from civil aerodromes are based on radio beacons and ranges. In some flying zones a rapid change-over from one beacon to another is required, and to enable this to be done as quickly as possible three of the French made radio compasses provide means for instantaneous change-over of frequency. In the S.F.R. and Radio Air models a mechanical "memory" arrangement is included whilst in the S.I.N.T.R.A. equipment 18 pre-set, crystal-controlled frequencies are provided. In the mechanically tuned receivers the procedure for enabling the change-over to be made is for the pilot to tune the receiver to the second frequency required—such as the last beacon frequency wanted for a given procedure—and to close a "storing switch," after which he can use the radio compass on any other frequency until the second one is wanted, which he

simply obtains by opening the "storing switch." The time taken for the compass pointer to settle to the new bearing is between 5 and 8 seconds.

In two radio compasses exhibited, including the British Marconi (see last issue p. 306), fixed-coil loop aerials were used, while Bendix showed their new "magnetic antenna." This aerial (Fig. 4) does not entirely dispense with moving parts at the aerial proper but greatly reduces the size of the search coil, thereby increasing the rapidity of action of the direction finder when seeking a new bearing.

The theory of the device is based on the ability of high-permeability ferromagnetic materials to conduct magnetic lines of force easily and to draw into their conducting paths more lines of force than would be found in an equivalent area in free space. In the Bendix loop, four ferrite poles, each with a short-circuited turn of wire round it, are placed at 90° to one another around a small coil, and their effect is to increase the number of lines of force across the coil. The orientation of the lines of force across the coil depends on the relative signal strengths in the collector rods. Thus pick-up in the quadrants of the aerial causes the maximum concentration of energy across the collector rods which lie transversally to the direction of the transmitting station. The lines of force therefore travel across the loop coil in paths parallel to the collector rods which are receiving the maximum energy. At angles of reception lying between the quadrants, the relative signal amplitudes in the collector rods result in a shifting of the magnetic lines across the coil so that they are parallel to the field in free space.

In the radio compass developed by the French firm S.I.N.T.R.A. the indicator is in the form of a small cathode-ray tube with a graduated scale round its periphery (Fig. 5). This avoids any moving parts in the direction finder proper when used in conjunction with a crossed loop with fixed coils. Operationally the cathode-ray tube indicator has the advantage of immediate indication of the disappearance of the signal and of very rapid indication of transit over the top of a beacon or "coning."

When the loop is installed in the aircraft, one coil is arranged to point in the line of flight, leaving the other at right angles to it. When a signal is received in the line-of-flight loop, its amplitude is proportional to the cosine of the bearing angle of the transmitter being received relative to the heading of the aircraft, whilst the amplitude of the signal received in the other loop is proportional to the sine of the angle. Each loop is arranged to feed into an r.f. transformer and thence into the grids of a double triode valve which also have applied to them an a.f. modulation of equal amplitude but in phase opposition. The outputs from the anodes of the triodes are then fed into a balanced transformer, thereby suppressing the carrier, but leaving the sidebands. The r.f. signal is also received on a small vertical aerial and, after amplification, fed into the r.f. transformer, resulting in a carrier with two sidebands. The phase of the modulation of the carrier is a function of the bearing of the transmitter relative to the heading of the aircraft. The modulated carrier is then amplified and detected and, after suppression of the d.c. component, applied to a pulse generating circuit where a pulse is formed each time the detected signal passes through a maximum. This pulse is applied to the cathode-ray tube and appears as a notch in the circular sweep corresponding to the bearing of the transmitter in relation to the direction of flight.

*See *Wireless World*, April, 1951, for principles and description of early type.

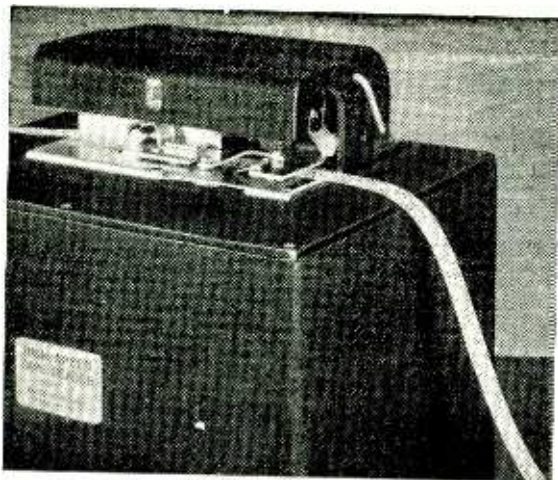

Fig. 1. Coded information in the form of punched holes in paper tape being fed into a high-speed reading device.

AUTOMATION is the magic word that seems to have everyone by the ears (and possibly by the nose as well) in the mass-production industries just now. Radio and electronics engineers, however, appear to be taking the idea very calmly, even with indifference; seeing it perhaps as little more than a new term which has just been invented to describe techniques they have known about for years. And certainly if one looks through the radio and electronics literature for the past decade there is plenty of evidence to support this attitude.

Electronic techniques, of course, are not the whole of automation, but it seems they have a big part to play in the new sphere (in so far as anyone can say what it is). This came out fairly well at the recent conference at Margate on "The Automatic Factory—What Does It Mean?" organized by the Institution of Production Engineers. The titles of some of the papers were in themselves a fair indication—"Automatic Electronic Control of Machine Tools," "Atoms, Electrons and Automation," "The Computer—Electronics Contribution to Production," "Automatic Inspection—The Anatomy of Conscious Machines," "Computer-controlled Machine Tools," "The Automatic Office—Industry's Electronic Pulse." Nevertheless it was clear from the content of these papers that the advent of automation (or at least the talk of it) has not so far elicited anything new from electronics. It has merely taken a number of established techniques in electronic measurement, computing and control and placed them under the heading of Automation, together with other equally well-established techniques from mechanical engineering.

It seems, then, that the present conception of "The Automatic Factory" is little more than an ordinary factory to which a large number of electronic (and other) control devices have become attached like barnacles on a ship. This is not greatly significant to the electronics engineer, because it merely means an intensification of his work along the same lines and not a radically new approach. There is, however, a much more highly developed view of the automatic factory which sees the whole organization, and not just the individual bits of machinery, controlled and co-

The Automatic

WHAT SCOPE DOES IT

ordinated by automatic means. (It is sometimes forgotten that there is more to a factory than just the manufacturing processes themselves.) To use a biological illustration, whereas the former conception is equivalent to little more than a mass of disconnected local reflexes all working independently (such as the automatic control of the pupil of the eye with varying light), this highly developed idea is more like a complete animal, with all its sensing and actuating organs not only reacting to local conditions but controlled and co-ordinated by a central nervous system.

Here then is considerable scope for the electronics man—in the design of information-handling systems for overall control and in the linking of these systems to the local electronic control devices. To elaborate on the possibilities we cannot do better than quote from a recent edition of a book* by Norbert Wiener, the American mathematician, who is known principally for his writings on cybernetics. Describing an automobile factory of the future he says: "In the first place, the sequence of operations will be controlled by something like a modern high-speed computing machine. In this book and elsewhere I have often said that the high-speed computing machine is primarily a logical machine, which confronts different propositions with one another and draws some of their consequences. . . ."

"The instructions to such a machine, and here, too, I am speaking of present practice, are given by what we have called a taping (Fig. 1). The orders given the machine may be fed into it by a taping which is completely predetermined. It is also possible that the actual contingencies met in the performance of the machine may be handed over as a basis of further regulation to a new control tape constructed by the machine itself, or to a modification of the old one. . . ."

"The computing machine represents the centre of the automatic factory, but it will never be the whole factory. On the one hand, it receives its detailed instructions from elements of the nature of sense organs, such as photo-electric cells, condensers for the reading of the thickness of a web of paper, thermometers, hydrogen-ion-concentration meters, and the general run of apparatus now built by instrument companies for the manual control of industrial processes. These instruments are already built to report electrically at remote stations. All they need to enable them to introduce their information into an automatic high-speed computer is a reading apparatus which will translate position or scale into a pattern of consecutive digits. Such apparatus already exists, and offers no great difficulty, either of principle or of constructional detail. The sense-organ problem is now new, and it is already effectively solved.

"Besides these sense organs, the control system must contain effectors, or components which act on the outer world. Some of these are of a type already familiar, such as valve-turning motors, electric clutches and the like. Some of them will have to be invented,

* "The Human Use of Human Beings," revised edition 1954, Eyre and Spottiswoode.

Factory

OFFER ELECTRONICS?

to duplicate more nearly the functions of the human hand as supplemented by the human eye. . . ."

"Of course, we assume that the instruments which act as sense organs record not only the original state of the work but also the result of all the previous processes. Thus the machine may carry out feedback operations, either those of the simple type now so thoroughly understood, or those involving more complicated processes of discrimination, regulated by the central control as a logical or mathematical system. In other words, the all-over system will correspond to the complete animal with sense organs, effectors, and proprioceptors, and not, as in the ultra-rapid computing machine, to an isolated brain, dependent for its experiences and for its effectiveness on our intervention. . . ."

Undoubtedly Wiener's description is very much of a pipe-dream at the moment (or should we say a pipe-nightmare?), but it comes from an informed imagination and should not be dismissed too lightly. Already, in fact, we are beginning to see the initial developments. On the purely manufacturing side there are automatic electronic devices using "sense organs" and "effectors" coming into use for the control of continuous processes, while on the organizational side electronic digital computers, originally introduced into factories for straightforward accounting work, are being used to assemble data for production control purposes. What Wiener refers to as "the general run of apparatus now built by instru-

ment companies for the manual control of industrial processes" could be seen in great variety at the recent British Instrument Industries Exhibition. The newer "information-handling" side was also well represented. For example, both Fielden and Elliott were showing automatic devices for continuously monitoring industrial plant by sampling physical variables (e.g., temperature, flow, level, pressure) at various points and printing out the results on paper (Fig. 2). Electronic discriminating circuits detect when the values are above or below pre-set limits, and cause the appropriate alarms to be given. The British Iron and Steel Research Association were showing how the angular position taken up by a shaft in a self-balancing servo system can be automatically registered in digital form as a decimal number and a coded version of it recorded as punched holes in a paper tape. Such "analogue-to-digital converters" are, of course, essential components in apparatus for numerical monitoring.

In another type of work an important development for the metal-working industries is the computer-controlled machine tool, which is now emerging from the laboratory and being sold as a commercial product. The Ferranti equipment, which has already been described in *Wireless World*†, was the subject of a paper by D. T. N. Williamson at the Margate conference, and some of the computer circuitry was shown in a small exhibition which ran concurrently (see Fig. 3). The computer here is used for interpolation between points of change on the contour to be machined, and is a digital machine plotting out the curves point by point. R. H. Booth, of E.M.I. Engineering Development, showed, in another paper, how the same sort of interpolation could be achieved by analogue computing techniques, and there was

† "Electronic Positioning," *Wireless World*, January, 1955.

Fig. 2. Electric typewriters, suitably modified, are convenient devices for automatically recording sampled values. This unit is actually the electronic part of an automatic weighing and filling equipment.

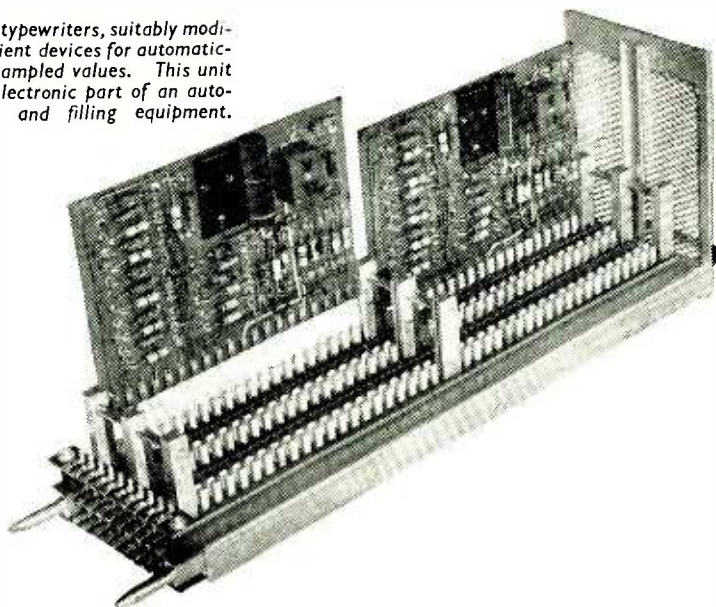
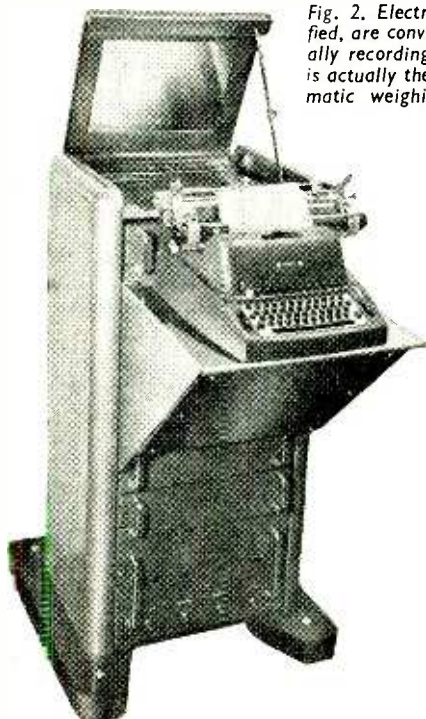

Fig. 3. The digital computer used in the Ferranti computer-controlled machine tools is built up from replaceable plug-in drawers, each of which contains a number of logical units in the form of replaceable plug-in circuit cards. Most of the actual computing is done with semi-conductor diodes, and thermionic valves are used only for amplification between logical operations.

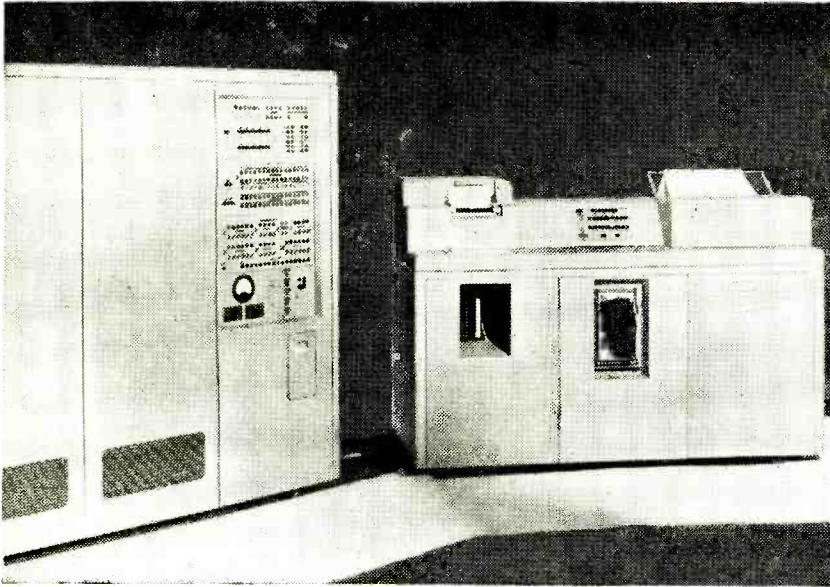

Fig. 4. Commercial electronic digital computer suitable for production planning. The unit on the left contains the programme controller and arithmetic unit, while on the right is a tabulating machine which feeds in information from punched cards (left-hand side) and automatically prints the computed results (right-hand side). This computer and the equipment in Fig. 2 were developed by the British Tabulating Machine Company.

considerable discussion on the relative merits of the two rival methods.

The use of computers for the overall planning of factory work was also discussed by Mr. Booth. He envisaged a machine into which could be fed information on the articles to be manufactured (in terms of the processes needed to make them) and out of which would be obtained information on such things as completion time, costs and requirements for fresh supplies of raw materials. To do this the computer would have to incorporate storage systems containing all the necessary reference data such as stocks of materials, available capacity for machining and assembly and costs of individual processes. A commercially built digital computer of the kind that could be adapted for such work was shown in the exhibition by the British Tabulating Machine Company (see Fig. 4). In the completely automatic factory, however, such a computer would do more than just produce results for human beings to act upon. Also fed into it would be the "operational" information from the plant monitoring systems described above, and this would be assimilated with the "planning" information to produce data from which the computer would control the plant automatically.

A more specialized type of computer for the control of continuous manufacturing processes was described by J. A. Sargrove and Peter Huggins, of Sargrove Electronics. It works on statistical principles and makes corrections to the processing machinery on the basis of error trends which it detects in the finished product. The apparatus (Fig. 5) includes a mechanical measuring device to sense the variations in the product, a transducer to turn these into electrical signals, a selecting device which samples the product at

suitable intervals and filters out unwanted information, and a "deviation classifier" which quantizes the error information into three distinct categories—"positive error," "no error" and "negative error." A statistical analyser then computes the sum of the errors, retaining in storage their net sense, and actuates correction timers (positive or negative, as appropriate) which by their time of operation control the amount of correction applied to the processing machinery. A "muting circuit," consisting of a timer, disconnects or paralyzes the statistical analyser until the corrected product is itself being sampled, while a "backlash compensator" increases the operating time of the timers if there is a change of sense in the correction. "Electronic brains" such as these are very specialized and limited in their abilities, with none of the flexibility which characterizes the human brain. It is a good thing, however, that they can be designed to replace the human operator, whose very complexity and desire for better things makes him unreliable as a control mechanism. As a character says in Karel Capek's play about robots, *R.U.R.*—"anyone who has looked into human anatomy will have seen at once that man is too complicated, and that a good engineer could make him more simply." The electronics engineer is now in the process of learning to do precisely that, although he may not know it.

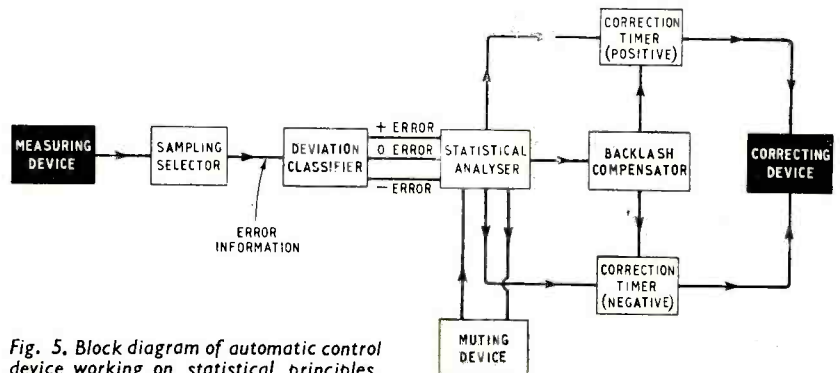

Fig. 5. Block diagram of automatic control device working on statistical principles.

Wide Range Electrostatic Loudspeakers

3—Complete Systems : Loudspeaker/Room Relationships

By P. J. WALKER*

IN the first part of this article we showed that for a given size, the apparent efficiency of an electrostatic unit may be increased by reducing the bandwidth which that unit is required to cover. An obvious method of increasing the overall efficiency of a complete electrostatic system, therefore, is to divide the system into a convenient number of frequency bands and to feed them via crossover networks. Optimum design is obtained by increasing gaps and areas with decreasing frequency.

An alternative method of increasing apparent efficiency is to subdivide the loudspeaker area into a number of smaller units each covering the whole frequency range, the units being coupled by inductors so that the whole loudspeaker becomes a transmission line. (Fig. 1.) The acoustic radiation resistance appears as conductance in parallel with each capacitive element. For a fixed total area, and neglecting losses, the efficiency varies directly with the number of subdivisions.

Consideration of these two systems shows that frequency division has considerable advantages over transmission line divisions for most complete systems of domestic size and power requirements. First, if a

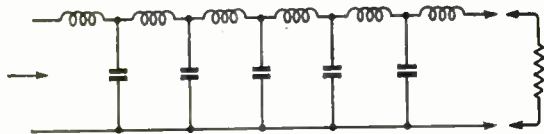

Fig. 1. Capacitive loudspeaker elements coupled with inductances to form a transmission line.

single nine-octave unit is subdivided into a two-unit system, the apparent efficiency is increased 16 times. To obtain the same increase by transmission line division would require a minimum of 12 divisions. Unless the total area of the loudspeaker is large, and the plate separation small, the capacitance of each section of the transmission line becomes very small indeed and requires correspondingly large inductance which must be of relatively high Q.

This apparent efficiency advantage of frequency subdividing over transmission line dividing holds until the bandwidth of each unit is reduced to two octaves.

Apart from transmission line subdivision applied to individual units of a frequency-divided system, practical consideration normally limits transmission line techniques to large-area diaphragms. When such is the case, however, additional facilities are available to the designer both in the accurate control of directional characteristics and in providing a constant phase contour, independent of frequency.

In discussing various possible forms of complete

electrostatic systems, a novel situation arises. The quality criterion of a loudspeaker usually concentrates on three performance parameters, as measured in an unlimited atmosphere. (a) Ability to produce a required sound intensity over the audio spectrum with negligible non-linearity distortion. (b) The sound pressure over the designated listening area should be independent of frequency throughout the audio range. (c) Operation should be aperiodic.

Complete loudspeakers designed on the principles which we have been discussing are capable of meeting these three requirements to a new and exciting degree. We shall see that different designs and approaches differ not so much in terms of (a), (b) and (c) above, but in other factors of importance to quality reproduction; factors which have previously had to take second place or have been masked in the struggle for (a), (b) and (c).

Corner Mounting

There has been a strong tendency in loudspeaker design to make use of the corner of a room. This is because at low frequencies the air load resistance for

a given size of diaphragm is increased 8 times over that of an unlimited atmosphere.

Since the ratio of cabinet "stiffness" to air load resistance is independent of diaphragm size, any increase of resistance due to boundary walls and floors fundamentally reduces the size of cabinet required for a given performance.

As an example, the form of corner electrostatic loudspeaker illustrated in Fig. 2 and designed for full performance down to 40 c/s utilized an internal resonance with a Q of 3 and a built-in enclosure of 10 cu ft. Fundamentally the enclosure size could be reduced either by (1) increasing Q, (2) reducing power and apparent efficiency requirements, or (3)

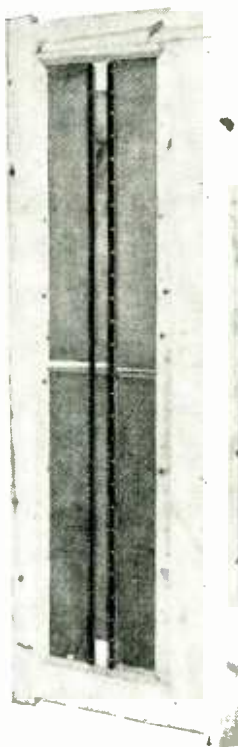

Fig. 2. Wide-range electrostatic loudspeaker in a resonant corner enclosure.

* Acoustical Manufacturing Co. Ltd.

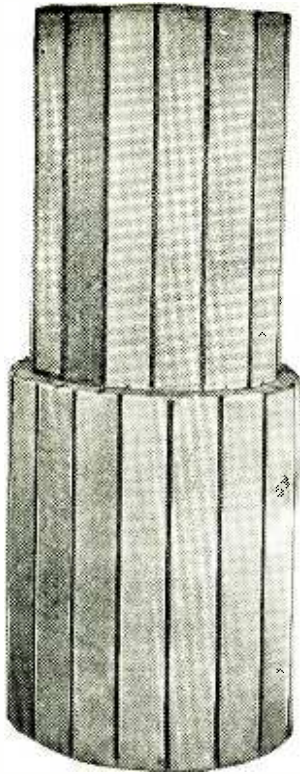

Fig. 3. Cylindrical electrostatic loudspeaker. Each strip carries the full frequency range and the sections are coupled to form an electrical transmission line. The inductor assembly is shown below.



restricting frequency range. Any one factor may be traded for any or all of the others.

It should be noted that with the diaphragm area of Fig. 2 the resistance could be substantially increased by reshaping the whole of the low-frequency area near the floor so that, with the boundary reflections, its dimensions laterally and vertically are similar. Such a form, with a suitably shaped treble unit above it, can be designed to give a level response in direct radiation to the listening area, so that the (a), (b), (c) requirements are not affected. Homogeneity on the other hand, due to the physical spacing of units, is destroyed. This may be more important than is generally realized, particularly in rooms of normal domestic size.

The high-frequency section (centre strip in Fig. 2) is sealed at the rear by an enclosure of width equal to that of the strip and incorporating a fibreglass wedge to offer almost pure resistance throughout the range of the unit. This sealing is necessary in order to maintain front air load resistance by preventing coupling between front and back.

Fig. 3 shows an entirely different form of corner design. The diaphragm area covers the whole surface and extends around the back to form an enclosed cylinder. Every part of the diaphragm carries the whole frequency range. The surface area is divided into units to form a transmission line. The total volume is 15 cu ft. The step in diameter is introduced because the transmission line rotates around the top portion and thence around the bottom portion. The time delay in the sound expanding from the top portion to the diameter of the bottom portion is equal to the time delay of the electrical voltages in the transmission line.

The complete assembly is placed a small distance from the corner of a room so that the boundary reflec-

tors are aiding at the lowest frequency of interest. The large diaphragm area together with the boundary reflections provide a loading approximately equal to ρc at 30-40 c/s. Internally there is acoustic resistance treatment, so that there will be resistive loading at high frequencies, changing to a capacitive load due to the lumped enclosure at low frequencies. Simplified equivalent circuits for high and low frequencies are shown in Fig. 4. The turnover occurs at about 400 c/s and it is obvious that with constant voltage the response will be level above 400 c/s and drop at 6dB/octave below this frequency. This is corrected by progressively rematching to the amplifier below 400 c/s. The section shape may be elliptical to give a degree of direction at high frequencies.

It is obvious that the corner boundaries will introduce peaks and troughs throughout the frequency range. These are, however, exactly the same as occur naturally with live speech or music originating near boundaries in a room. To what degree these effects are important must at the present time be a matter of conjecture. It can safely be said that the subjective effect is by no means as alarming as the appearance of the response curve.

The advantage of a corner position has already been noted. This advantage is not gained without considerable detriment in other directions. If we wished to excite every room-resonance to its fullest extent with a sound source of high internal impedance, we put this source in a corner because this is the position of highest impedance for every mode. In placing our loudspeaker in a corner therefore we are placing it in the *worst possible* position if our aim is smooth aperiodic sound.

Although the present trend appears to be to tolerate this state of affairs in the interest of the organ's 32ft rank (or reduction of cabinet size), the inherent smoothness of electrostatic loudspeakers once experienced is not lightly thrown away, and there is added impetus in attempts to improve the loudspeaker/room relationship.

Double Wall Enclosure

The strip "twin" unit design of Fig. 2 may be built into a wall in such a way that most room modes are not excited or are excited only feebly. If it is an outside wall, the rear enclosure may be added externally. If an inside wall it may spread over the wall so that from the appearance point of view it has virtually disappeared. Fig. 5 shows the general form of installation. The strip unit extends from floor to ceiling and the low-frequency sections are backed by 5in wide enclosures $4\frac{1}{2}$ ft in length, with fibreglass wedges incorporated. The impedances and response are shown in Fig. 5 (June issue). With the dimensions of this example, $d=10$ in since both 5in units are coupled, and the response will be within 3dB of 1 kc/s response down to 35 c/s. These figures include floor, one wall and ceiling, but do not, of course, include the effects of other room boundaries. Assuming a 2in thick wall for rigidity, the volume of a room of 300 sq ft floor area would be reduced by 2%.

There can be no initial excitation of floor to ceiling modes because vertical excitation is evenly distributed. Modes excited in a direction parallel to the wall on which the speaker is mounted will be reduced in number. Assuming a rectangular room, the number of modes excited will be some four times less than the number excited by a corner floor position.

As can be seen by the following summary, this form of loudspeaker leaves little to be desired.

1. The enclosure being "built-in" can be completely rigid.
2. The only fold in the enclosure is narrow compared to wavelength and being close to the diaphragm can cause no reflections in the range of that unit.
3. The loudspeaker and its enclosure are completely predictable.
4. The (a), (b) and (c) requirements previously mentioned can be met virtually to perfection.
5. Radiation throughout the whole frequency range is homogeneous; there is no source displacement and no phase problems at crossover.
6. Total radiated energy (as well as axial pressure) is independent of frequency.
7. The loudspeaker/room relationship is good.

Item 6 deserves further mention. The normal frequency response specification of a loudspeaker is in terms of sound pressure produced on the axis or over a limited listening arc. The mean spherical radiation (total power output) is not usually specified, although it will have a profound effect in a room because the intensity of indirect sound is dependent upon it. If high-frequency radiation is limited to a segment of, say, $90^\circ \times 30^\circ$ (a typical figure) and bass radiation is hemispherical, and if the axis response is level, then there will be a step of 12dB in the mean radiated response. This produces an artificial step in the acoustic ratio (ratio of direct to indirect sound) producing unnatural hardening of the reproduced sound.

Doublet Sources

We now come to consideration of the doublet as a sound source and we shall see that it possesses properties of considerable significance in improving loudspeaker/room relationships. By a doublet we mean a diaphragm, radiating on both sides.

If we assume a 12in-15in unit (moving coil or electrostatic) mounted in a 4ft-5ft baffle, we find that the

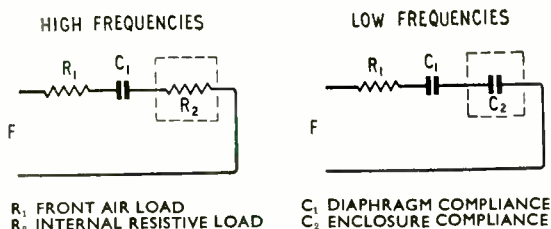

Fig. 4. Equivalent circuits at high and low frequencies of the acoustic loading on the loudspeaker of Fig. 3.

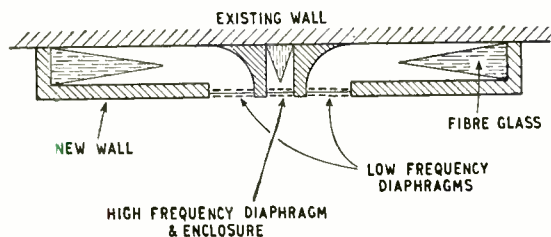

Fig. 5. Sectional plan showing one method of rear enclosure for a strip electrostatic unit.

acoustic system has three main faults. (1) The acoustic air load falls to very low values at wavelengths larger than the baffle size. (2) The acoustic load is very irregular at low frequencies and (3) reflections from the baffle edge occur at higher frequencies. The second, and third faults can be mitigated by adopting peculiar shapes.

If, instead of a baffle, we construct a composite electrostatic unit of the same area, the position is completely altered. The resistance per unit area and the total working area are both increased so that the air load is many times that of the baffle case. The load, and consequently the performance, is regular and predictable.

The construction is that of strip units progressively increasing in plate spacing and area from the centre line. Due to the air load resistances involved for each strip, the permissible bandwidth is reduced over that which could be obtained if the back radiation were sealed off and it is necessary to split the frequency range into three to obtain efficiency comparable to a two-way "sealed" system.

Any unloaded strip considered alone will have a resonant frequency when the diaphragm stiffness reactance equals the air load mass reactance. This is, however, placed below the frequency range of the strip, so that the mutual radiation of the adjacent strip carrying a lower frequency range increases the radiating area and prevents the application of any effective mass. The complete system is therefore entirely free of resonance except at one low frequency (usually placed at 30-35 c/s). The Q of this resonance is adjusted to maintain response to this frequency.

The complete loudspeaker has a cosine characteristic and this is substantially maintained through the range. It cannot radiate sound in the direction of its surface, horizontally or vertically, so that it cannot excite room modes in two out of the three room dimensions. It will only excite modes in the remaining dimension when placed at a region of maximum velocity for that mode. (The impedance looking into the loudspeaker is low.)

Having a "cosine" polar characteristic the mean spherical radiation is reduced by a factor of 3 at all frequencies, so that quite apart from freedom of mode excitations any colour due to the room is reduced by a factor of three. This is exactly analogous to a "velocity" microphone. In the same way that a "velocity" microphone is used in place of a "pressure" microphone to reduce studio colour, this "velocity" speaker will reduce colour due to the listening room.

Listening tests comparing "pressure" and "velocity" speakers of otherwise similar characteristics indicate that a velocity characteristic may well have important features for high-quality reproduction. An electrostatic loudspeaker of this type correctly positioned in the room meets all requirements as did the "wall" form previously described, with the addition of an even better loudspeaker/room relationship. The fact that it requires to be free standing well within the room may or may not be advantageous.

The more the acoustic ratio is reduced (provided always that it is reduced equally at all frequencies), the more one approaches the state of affairs that the pressure at the ears is a replica of the pressure at the position of the microphone in the concert hall or studio (ideal headphone conditions). It must be emphasized that many arguments for and against this condition have been proposed. It is outside the scope

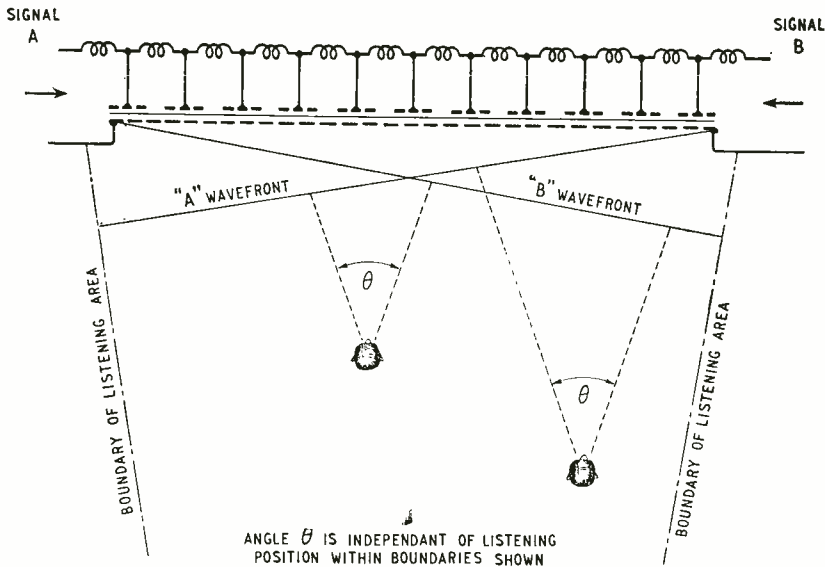

Fig. 6. Stereophony from a single transmission line loudspeaker, with separate channels feeding each end of the line.

of these articles to enter these arguments other than to say that with a monaural channel the choice must be an æsthetic one.

A complete listening room can be designed to produce pressures throughout the room which are more or less equal to the pressures at the studio microphone.

A tube of small diameter compared to wavelength fitted with a piston at one end, and terminated at the other by a resistance of ρc will give pressures anywhere in the tube which are directly proportional to piston velocity and independent of frequency. Provided that the area of the piston equals the tube cross-sectional area, then the requirement of small diameter disappears.

A rectangular room with a diaphragm covering one wall and correct termination on the opposite wall meets the requirements. The space behind the diaphragm must be at least 10in deep and treated like the speaker in Fig. 3. The equivalent circuit is the same as Fig. 4. The sound absorption treatment of the opposite wall must ideally be several feet in depth.

Sound intensity throughout the room is independent of position (including the distance from the diaphragm). The apparent sound source is always in a direction perpendicular to the diaphragm and, of course, moves as the listener moves.

The same loudspeaker may be used for stereophony. With transmission line matching and feeding the signal at one end the wavefront will be tilted, due to time delay. Separate signals may be fed from either end to produce two tilted wavefronts, one for each signal. Since each apparent origin is perpendicular to its wavefront, the aspect angle from the listener is a constant and entirely independent of the listener's position over a large triangular area (Fig. 6). The relative intensity of the two signals is also constant.

A fixed angle, two-channel system of this type may be obtained with a less elaborate listening room. The strip arrangement of Fig. 5 may be installed horizontally instead of vertically. If each unit is a transmission line along its length, then two cylindrical wavefronts will be produced with exactly the

same feature of constant aspect angle already described.

To summarize, the electrostatic principle is capable of surmounting the present limitations of other methods of drive. It is capable of overcoming the present tweeter/woofer concept to produce a closely coupled, integrated assembly. The problem of loudspeaker/room relationships (common to all loudspeakers) still remains, although the design versatility of the electrostatic makes it possible to design for optimum relationship if these can ever be defined for a monaural channel.

A closer understanding of the relative importance of the many factors involved are needed. (a) Source movement with frequency, (b) Homogeneity, (c) Acoustic ratio, (d) Mode excitation, (e) Phase contour, etc. All are factors which can only be tentatively assessed after long usage.

The author wishes to thank Ferranti Ltd. for permission to publish the result of work jointly carried out, and to acknowledge the invaluable work of D. T. N. Williamson, W. D. Oliphant, and their colleagues at Edinburgh. Thanks are due to J. Watson, J. Collinson and others at the Acoustical Manufacturing Company, and to the several specialists who have been able to assist with problems in their own field.

COMMERCIAL LITERATURE

Thermocouples, vacuum and air types, suitable for measurement of r.f. voltages and currents in conjunction with m.c. meters, described in leaflet giving ranges available from Ormandy & Stollery, 56, High Street, Brightlingsea, Essex.

Multi-range Test Meter covering a.c. and d.c. voltage, each in six ranges, a.c. current in one range, d.c. current in six ranges and resistance in two ranges. Specification on a leaflet from Measuring Instruments (Pullin), Electric Works, Winchester Street, Acton, London, W.3.

Printed Circuits by the "Plasmet" process. Hints to designers on the preparation of suitable circuit layouts given in a folder from Printed Circuits, Whadoat Street, London, N.4.

Test and Measuring Instruments by Hewlett-Packard (U.S.A.) obtainable in this country at 8s per dollar plus duty where payable. Short catalogue, giving brief details of major instruments, from Livingston Laboratories, Retcar Street, London, N.19.

Ceramic Trimmer Capacitors suitable for pre-set adjustment of r.f. and oscillator circuits in television tuners. Maximum capacitances from 3 to 20 pF. Also electrolytics with very low leakage currents and subminiature electrolytics for transistor circuits. Technical bulletins from The Telegraph Condenser Co., North Acton, London, W.3.

Band-III Television Converter with PCC84 s.f. amplifier and ECC81 oscillator and frequency changer. Models available for double-sideband and single-sideband receivers (for London area). Brief technical specification on a leaflet from Invicta Radio, 100, Great Portland Street, London, W.1.

Tape-to-Disc Transfer Service and other recording services. Leaflet giving brief details and prices of records from Sound News Productions, 59, Bryanston Street, Marble Arch, London, W.1.

General view of the complete fitment. At the left-hand side of the centre section is the 15in speaker, with the treble speaker assembly on the top of the fitment. The only part of the top that opens is on the extreme right-hand side where the transcription motor is situated. The upper part of the centre of the fitment is a steel drawer in which are contained the tape recorder, f.m. tuner, pre-amplifier, amplifier and cross-over unit. Three drawers underneath each accommodate 40 boxes of tape. Five cupboards provide storage space for records or tape and in nine small drawers tools and stationery are kept. The drawer underneath the gramophone turntable was made to correct dimensions to house a ribbon microphone.



High-Fidelity Home By Richard Arbib

A SOLUTION TO THE PROBLEM OF LIVING WITH AUDIO EQUIPMENT

IT is hard to determine whether it was the difficulty of finding room for the 91st tape, the wish to have sand in the sitting room, or the fact that the new Garrard 301 transcription motor was so massive that it would not fit along the side of the Leak "Varislope 2" pre-amplifier in the only available space in the existing cabinet. They had both been mounted temporarily in tiers and it was very awkward to adjust the controls on the pre-amplifier by threading the hand under the transcription motor. Incidentally, if it is thought that the possession of 91 tapes is plutocratic, it should be remembered that quite a number of people collect thousands of stamps.

Built-in Furniture Fitment. At last the decision was made. The window alcove in the sitting room should house an elaborate furniture unit to incorporate all the equipment which had been spread around the room or kept in the radio-gramophone cabinet. This had been made specially, more than a quarter of a century ago, with the idea that it would accommodate any developments of the future. However, this thought had now been proved to be erroneous, for it was designed at a time when life was simple and gramophone records were made to play at only one speed, tape machines had not been invented and only one loudspeaker was used at a time in a room.

In the window alcove there had been a writing desk, and at once an argument arose as to how one was to write letters without a desk. However, it was remarked that in this electronic age, one should not write letters at all, and writing was needed only for cheques. Any correspondence could be undertaken on tape and either transcribed by a secretary or heard by the recipient.

As is usually the case in planning any new development, the first thing was to undertake some research

and thus many *Audio* and *High Fidelity* American magazines were perused. In their pages are illustrated the elaborate high-fidelity installations which, with ranch houses, Cadillacs and typewriters that type as though they are printing, have become the essential acquisitions of the successful American executive. However, an examination of these designs showed clearly that whilst they housed all the pieces of equipment which were considered necessary for the addict of high fidelity, much of the apparatus was situated in a way which was most difficult to operate. It is very nice to have a tape recorder built into a room, but many will agree that it is inconvenient to have to lie on the floor to change the reels.

Basic Principles. In designing this equipment, therefore, it was decided that three basic principles had to be observed. First, everything had to be right technically. For example, the pickup must be some distance away from the loudspeaker. All equipment must be accessible for operation and must be capable of being withdrawn from a fitment in a time not exceeding five minutes. To the service engineer who has to struggle with the servicing of many television sets in a day, this time may appear to be excessive, but in view of the reliability of the units concerned, it was considered that five minutes would not be an undue time. Furthermore, it was also thought that every standard unit should be unaltered. For example, the tape recorder should not be taken out of its original case, for if any section did want servicing, it could be withdrawn as a complete unit and thus returned easily to the manufacturer.

After having attempted for some years to read the titles on tape boxes sideways in bookcases, it was decided that the majority of the tape boxes should be kept in drawers in such a way that they could be located easily. It was thought that the basic storage

space available should be capable of housing 100 12in records and 200 reels of tape.

Although the window alcove was 7ft wide and 5ft deep, one snag was that a height of only 31in was available under the windows. However, it was agreed that the whole of this space should be occupied by the units, loudspeakers and nine small drawers for stationery and odd tools which had been kept previously in the desk. As, apparently, most wives insist on putting vases of flowers, photographs, ash trays and other bric-à-brac on top of furniture, it was arranged that only one small portion of the installation should have a lid which opened. Although record changers may be placed in drawers, it was realized that a transcription motor with a pickup weighing only a few grams should not be mounted in anything movable, and thus of the whole surface area of 22 sq ft only 3 sq ft lifts up.

Accommodating the Units. The basic units which had to be accommodated comprised a 15-in Wharfedale loudspeaker, which, from the counsels of Mr. Briggs, it was appreciated must be housed in a cabinet exceeding 9 cu ft, 8-in and 5-in speakers which should be mounted in an open form of baffle, a Ferrograph Model 2A tape recorder, a Leak TL12 amplifier and "Varislope 2" pre-amplifier, an American Browning f.m./a.m. tuner, which had been brought over to this country long before British f.m. tuners were available, and the Wharfedale 3-way cross-over network unit. Furthermore, a panel was required for switches. The gramophone equipment, for which space had to be found, was a Garrard 301 transcription motor with a Leak moving-coil pickup and arm. Arrangements had to be made for feeding the output to the loudspeaker network, which has been in existence for some time and extends to practically every room in the house.

Owing to the comparatively low height of the top level of the fitment, it was decided that the only way in which to operate the Ferrograph and the amplifier controls conveniently, was to mount everything, except the loudspeakers and the transcription motor, in a drawer. From the accompanying illustrations it will be clear how the units are arranged. The steel drawer was made in two sections and welded together, the Ferrograph drops in on the left-hand side, the TL12 amplifier is in the base of the right-hand side. Mounted above it on a shelf is the Wharfedale cross-over network unit to the controls of which extension rods have been fitted so that the potentiometers on the medium and treble cross-over network sections are controlled by knobs mounted on the top panel. The f.m. tuner unit is mounted behind and the little available space in front of that is occupied by a felt-lined recess in which a small crystal microphone is kept and which is connected permanently to the appropriate socket on the Leak pre-amplifier. This unit is mounted at the front of the drawer at the same angle as the control panel of the Ferrograph. A ribbon microphone is used also and this is kept in a special drawer below the gramophone motor.

A potentiometer has been added at the tape input socket of the Leak "Varislope 2" so that the levels from the Ferrograph, the tuner unit and the pickup are all the same. On the left of the "Varislope 2" is a special control panel which has four switches and four jack sockets. Reading from left to right (1) switches the TL12 amplifier to the three loudspeakers through the cross-over unit, (2) switches the amplifier to the extension loudspeaker network, (3) switches the

output of the Leak amplifier, either to the three loudspeakers through the cross-over unit or direct to the 8-in loudspeaker, when it is required to reproduce speech only, and (4) switches off everything at the mains, irrespective of the positions of the switches on the individual units. The jacks below are: (1) connected to the three loudspeakers, (2) connected to the external loudspeaker network, (3) connected to the output of the tuner, and (4), connected to the sound output of the television set which is situated in another part of the same room. The jack sockets are provided for the three loudspeakers and the extension network in case it is wished to feed the output of the Ferrograph direct to these speakers without going through the Leak amplifier. In the same way the tuner socket is used for feeding from the tuner into the Ferrograph. The tuner is also connected permanently to the appropriate socket on the pre-amplifier.

Operation.—One length of shielded cable with screened jack plugs at each end and the various sockets are used as follows. If it is wished to record a radio programme the output is taken from the tuner socket on the small panel and fed into Input 2 of the Ferrograph, the monitoring to the tape machine being undertaken by the gain control on it. A programme can be recorded without it being heard in the room, or if it is wished to be heard in the same room or another room the appropriate loudspeaker switches are thrown and the gain control on the "Varislope 2" adjusted to a suitable volume. If it is desired to record a television programme, the jack is plugged into the TV socket on the sub-panel. If the TV programme is desired to be heard through the Leak amplifier either in the same room or around the house, the output is fed from the TV socket to the input jack socket on the pre-amplifier. To record speech from the room the main control switch on the pre-amplifier is turned to "microphone" and the output from the pre-amplifier connected to Input 2 of the Ferrograph. If it is desired to reproduce a gramophone record on tape, the same procedure is observed with the Leak main control knob in the position to suit the frequency response of the record concerned.

Loudspeaker Mounting.—The arrangement for the loudspeakers is that the section of the fitment for the 15-in speaker has the sides made of 1-in wood, 1-in of sand and $\frac{1}{2}$ -in of plywood. The front has a port 12-in \times 6-in. On the main top of the fitment is situated the assembly for the 8-in and 5-in speakers. As the height of the alcove is only 7ft the two speakers do not point upwards but are at an angle of 45° into the room. In order to obtain a simple and attractive design, they are mounted on a flat baffle which is held by skeleton woodwork at an angle of 45°, the front and the sides being covered by expanded metal, and the back is open.

The Garrard 301 transcription motor is mounted on a motor board which floats on springs. Also mounted on the motor board is a light which illuminates the turntable and an extra switch which stops the motor without any danger of the pickup being moved.

Cabinet Work.—The finish of the whole cabinet work is bird's-eye maple for the exterior of the front and interior of the cupboard doors, motorboard and panel above the tuner unit. The top is of walnut and the drawers are made of mahogany veneered on the outside with bird's-eye maple.

The front of the steel drawer which accommodates the recorder, amplifier, f.m. tuner, etc., is a dummy

to the extent that it has five handles or knobs but opens as one drawer. The units in this drawer have, with the drawer, a combined weight of about 2cwt. The drawer is mounted on Admiralty pattern ball-bearing slides and moves forwards and backwards easily. The wood front is hinged at the top so that the recorder and pre-amplifier controls may be operated without pulling out the drawer.

Having all these units in a comparatively confined space does, of course, raise the problem of ventilation. This has been solved by having the underside of the left-hand section of the drawer completely open except for two channels on which the Ferrograph rubber feet rest. The sides of this section of the drawer are cut away to coincide with the loudspeaker fret and ventilation holes of the recorder case. The other side of the steel drawer has slots 17in x 2in cut at the lower ends of the back and sides. Holes are provided at the top of one side, in the felt-lined recess, and an expanded metal grille is mounted between the pre-amplifier control panel and the switch-jack panel, which have purposely been fixed half-an-inch apart.

The large drawer at the side and the two underneath the steel drawer are of the exact dimensions to take boxes of 7in and 8½in reels of tape respectively. Each drawer takes two rows of 20 tapes which are filed with the titles uppermost and in line with the front of the drawer. Three shelves in the large right-hand cupboard each accommodate 25 tapes. Four smaller cupboards, whilst being of the correct dimensions to accommodate 12in records could, of course, be used for the storage of tape.

Having spent many hours in making the necessary drawings for the furniture fitment and undertaking all the wiring and connections, of course the question asked most frequently by other high-fidelity enthusiasts is, what alterations would be made if it was being designed all over again. The answer, quite honestly, is none. There is only one snag to the whole system which was apparent when it was planned originally, and that is the desirability of having the main loud-speaker assembly on the side of the room opposite the

control equipment, so that the volume could be adjusted from a distance. With the space available this was not possible, and the only refinement which could be introduced to the system other than stereophonic sound, for which space is available, would be remote operation for the main gain control of the amplifier.

What Next?—Other friends have said, "Well, now you have everything, what can you do in the future, other than record and listen?" Apart from stereophonic sound which will, of course, be coming along later this year, work has already started upon re-wiring the rest of the house with a system whereby the loudspeakers in each room will have individual volume controls and be operated through fourway switches. By this system the occupants of each room and the garden will have choice of the tape or record programmes from the equipment in the sitting room or the Home, Light or Third B.B.C. f.m. programmes. This system is a development of an idea suggested by Douglas Lyons, of the Trix Electrical Co., Ltd. In one cabinet in another room three f.m. tuners, each tuned to a different programme, will be connected to three 10-watt amplifiers. The outputs of these amplifiers will be connected to three pairs of the four-pair cable. The remaining pair replacing the existing extension speaker pair on the main sitting room equipment.

The three f.m. tuners and amplifiers will be switched on and off by a time clock set to switch on at 7 a.m. and off at midnight.

Acknowledgements. — In conclusion, grateful acknowledgement must be made for the assistance of the following friends who have given much technical advice which has been the means of avoiding many of the pitfalls which fall to the experimenter who tries to put together the parts of different manufacturers. Reference is made particularly to Hector Slade of Garrard Engineering & Manufacturing Co., Ltd., Harold Leak of H. J. Leak & Co., Gilbert Briggs of Wharfedale Wireless Works, Ltd., and E. H. Niblett of Wright & Weaire, Ltd. Yes, this article was dictated on tape!

The steel drawer pulled out with the flap covering the controls turned down. The tape recorder is on the left with a tape splicer mounted below the main control knob. Set at the same angle as the recorder control panel is the switch panel and pre-amplifier. On the panel above are the knobs controlling the potentiometers of the cross-over unit and the dial and controls of the f.m. tuner. In the felt-lined recess a crystal microphone is kept and is permanently connected to the pre-amplifier. The flap at the top right-hand corner is up to disclose the transcription motor and moving coil pickup. A lamp to illuminate the turntable is fitted on the motor board.

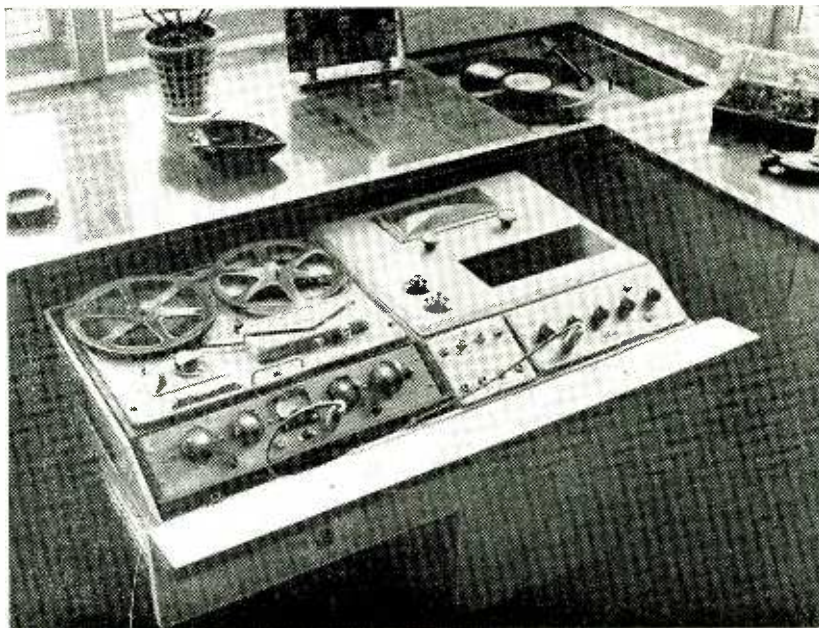

Transistor Equivalent Circuits

2.—Earthed-Emitter Junction Transistors

By W. T. COCKING, M.I.E.E.

IN Part 1, we developed an equivalent circuit for the thermionic valve. In doing this we started with the experimental evidence of the characteristics of the valve in the form of a family of curves relating anode voltage to anode current for a series of values of grid voltage. We then approximated these accurate curves by a series of equally-spaced parallel straight lines, which we may conveniently call a linear approximation. The next step was to find an equation which would represent this approximation algebraically and, finally, we found an arrangement of components which could be represented by the same equation. This formed an equivalent circuit.

The accuracy with which an equivalent circuit represents a valve depends entirely upon the goodness of the linear approximation. Over any range of voltages and currents where the straight lines fit the valve curves closely, the accuracy is good.

With the transistor, the procedure is exactly the same as with the valve. There is a complication, however. It is an experimental fact that all the electrodes of a transistor pass current, not two of them only as in the negative-grid valve. The transistor is more like a positive-grid valve in this respect. Because of this, two families of characteristic curves are needed to describe it and the equivalent circuit is more complex than that of the valve.

The newcomer to the transistor is apt to be misled by certain conventions which are commonly adopted. Most published characteristics are for the transistor in the earthed-base condition and many circuit diagrams show it used in this way. Also, in the usual transistor symbol, the base is represented by a heavy line which is not unlike the cathode symbol of a valve. It is hardly surprising, therefore, that the newcomer gets the impression that the base of a transistor corresponds to the cathode of a valve.

The base is, of course, the equivalent of the grid and the earthed-base transistor is analogous to the earthed-grid valve circuit. To anyone accustomed to valve circuits, it seems very wrong-headed to make the earthed-base circuit the basic one of transistor circuit theory. Actually, there are reasons why it is more suitable than the earthed-emitter circuit, but this is not the stage at which they can well be appreciated.

To the newcomer, however, the earthed-emitter circuit is the natural approach and this is the one that we shall adopt here. At first, only this circuit will be considered and only the junction transistor. This exists in two forms, the $n-p-n$ and the $p-n-p$. It consists essentially of two pieces of n or p type impurity germanium with a thin slice of the opposite kind sandwiched between them.

One of the end pieces functions as a source of

SUMMARY: As a sequel to the derivation of the equivalent circuit of the thermionic valve in Part 1, equivalent circuits for the $n-p-n$ transistor in the earthed-emitter circuit are developed here. They are based upon the same form of straight-line approximation to the transistor characteristics as was used for the valve. The characteristics of the transistor are represented by four quantities which are easily derived from the characteristic curves; they are base and collector a.c. resistances and forward and backward current-amplification factors.

It is shown that, within the limits of accuracy imposed by the straight-line representation of valve and transistor characteristics, the transistor is exactly equivalent to a thermionic valve having a cathode feedback resistance and a second resistance between grid and cathode.

charge carriers and the other as a collector of them; the one is called the emitter and the other the collector. The meat in the sandwich functions as a control electrode and is called the base. Emitter, base and collector are analogous to the cathode, grid and anode of a thermionic valve. With the $n-p-n$ transistor the analogy is rather close, because the internal conduction is mainly by electrons, with the result that base and collector are normally maintained positive to the emitter and the conventional currents enter at base and collector and leave at the emitter.

The $p-n-p$ transistor, however, is rather different. Internal conduction is by positive "holes." Base and collector must normally be negative to the emitter and the current enters at the emitter and leaves by the base and collector. There is no valve which behaves like this but if it were possible to make one with a "cathode" which emitted positrons instead of electrons it would do so.

The circuits of typical $n-p-n$ and $p-n-p$ transistors in the earthed-emitter connection are shown at (a) and (b) respectively of Fig. 1.

The $n-p-n$ Transistor

In Fig. 2 are shown the general forms of the characteristics of an $n-p-n$ transistor. The family of curves at (a) relates collector voltage and current for a series of values of base current, while the family at (b) relates base current and voltage for a series of values of collector current. If the curves at (a) were for values of base voltage V_b instead of base current I_b , they would be of exactly the same form as an ordinary set of valve curves and the ordinary equivalent circuit could be used.

Transistor characteristics can be plotted in terms of V_b , but it is customary to use I_b instead, mainly because a transistor has such a low input resistance that we are often more interested in current than in voltage.

In Fig. 2 (a), the dotted lines represent a linear approximation to the real characteristics upon which we base our equivalent circuit. We proceed in the

Fig. 1. The circuit diagrams of a simple transistor amplifier are shown at (a) for an n-p-n and at (b) for a p-n-p transistor.

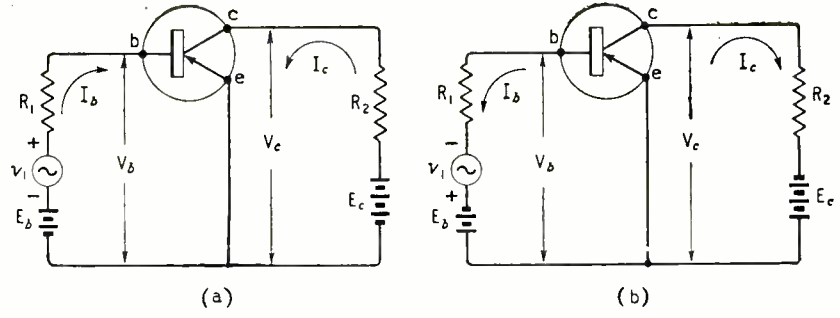

same way as in the case of the valve, which was described in detail in Part 1. Some line, not shown, passing through the origin, represents a resistance of value $\rho_{22} = V_c/I_c$. The slope resistance $\delta V_c/\delta I_c$ has the same value for this line. For any other line the value V_c/I_c does not apply but, since the lines are all parallel, they all have the same slope resistance which is, therefore, defined as

$$\rho_{22} = \delta V_c/\delta I_c \quad \dots \quad (1)$$

We are, for the present, using the Greek letter rho to represent resistance instead of the more usual r, because the latter is commonly used in equivalent circuits derived for the earthed-base connection and we want to avoid any confusion between the two. We are using the subscripts "22" to denote what, by analogy with the valve, we may call the collector a.c. resistance, because that is customary with transistors. This resistance, which we call ρ_{22} , is the transistor equivalent of the anode a.c. resistance of a valve.

The particular line in Fig. 2(a) for zero base current

($I_b = 0$) cuts the current axis at some current I'_c . The equation for the line through the origin is

$$I_c = V_c/\rho_{22}$$

The equation for the line $I_b = 0$ becomes simply

$$I_c = I'_c + V_c/\rho_{22}$$

and this derivation is exactly analogous to that for a pentode valve, Fig. 9 of Part 1.

We now define a current amplification factor

$$a = \delta I_c/\delta I_b \quad \dots \quad (2)$$

for constant V_c . This is merely the ratio of a change of collector current to the change of base current which causes it. The complete equation for Fig. 2(a) now becomes

$$I_c = I'_c + aI_b + V_c/\rho_{22}$$

which is more conveniently written as

$$V_c = I_c\rho_{22} - I'_c\rho_{22} - aI_b\rho_{22}$$

Now what does this represent? On the left-hand side, V_c is the externally applied collector-emitter voltage and is not part of the equivalent circuit of the transistor itself. $I_c\rho_{22}$ is an internal voltage drop due to the current I_c flowing through a resistance ρ_{22} . $I'_c\rho_{22}$ and $aI_b\rho_{22}$ can be taken to represent e.m.f.s acting round the circuit to assist V_c but internal to the transistor. The first term of the pair accounts for the offsetting of the $I_b = 0$ line of Fig. 2(a) from the origin; the second accounts for the effect of base current upon collector current.

The complete circuit which the equation represents is thus one like Fig. 3(a) in which the transistor part is shown boxed. It is the same as a valve equivalent save for the labelling of the elements.

Now consider the base characteristics of Fig. 2(b). A line through the origin represents a resistance $\rho_{11} = V_b/I_b$. This has a slope resistance $\delta V_b/\delta I_b$ which is the same for all lines. We, therefore, define the base a.c. resistance as

$$\rho_{11} = \delta V_b/\delta I_b \quad \dots \quad (3)$$

for constant I_c .

The equation for the $I_c = 0$ line is

$$I_b = I'_b + V_b/\rho_{11}$$

We now define a reverse current amplification factor as

$$b = -\delta I_b/\delta I_c \quad \dots \quad (4)$$

for constant V_b . This is the ratio of a change of base current to the change of collector current responsible for it. The negative sign comes in because it is convenient to have b as a positive number and $\delta I_b/\delta I_c$ is itself negative since an increase of I_c reduces I_b . The complete equation is now

$$I_b = I'_b - bI_c + V_b/\rho_{11}$$

This is conveniently written as

$$V_b = I_b\rho_{11} - I'_b\rho_{11} + bI_c\rho_{11}$$

This has the same interpretation as the one for the collector circuit and so a circuit to which this applies

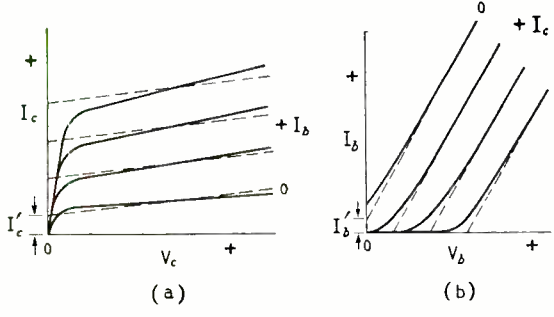

Fig. 2. Collector (a) and base (b) characteristic curves for an n-p-n transistor. The dotted lines represent ideal straight-line approximation to the characteristics.

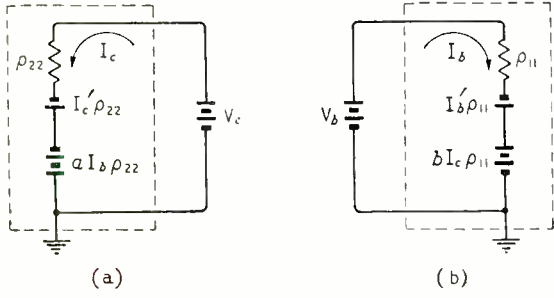

Fig. 3. D.C. equivalent circuit of an n-p-n transistor. The output side is shown at (a) and the input at (b).

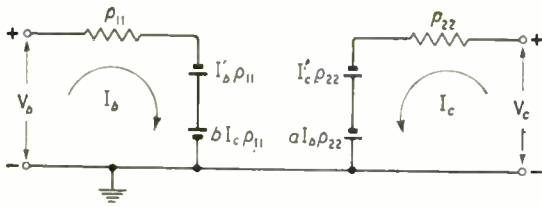

Fig. 4. Complete d.c. equivalent circuit of an *n-p-n* transistor. For a *p-n-p* transistor all voltages and currents are reversed.

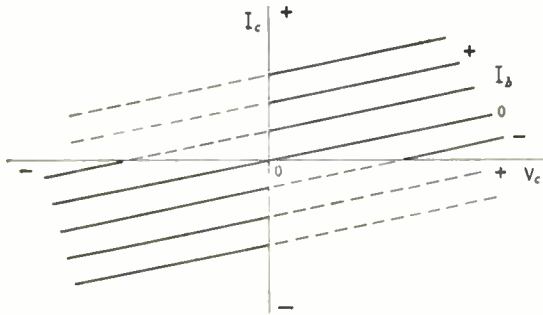

Fig. 5. This diagram as a whole is a graph of a resistance in series with a battery. The part in the first quadrant approximates an *n-p-n* transistor, while the part in the third quadrant approximates a *p-n-p* transistor.

has the form shown in Fig. 3(b). However, since $bI_c\rho_{11}$ has the opposite sign to $aI_b\rho_{22}$ it is connected the other way round, to oppose the external driving voltage.

The two circuits of Fig. 3 represent the input and output parts of the transistor and together, as in Fig. 4, they form one equivalent circuit of the *n-p-n* transistor. It is valid for d.c. conditions and accurate in so far as the linear approximations to the transistor characteristics are accurate.

The *p-n-p* Transistor

We have now to consider the *p-n-p* transistor. It is an experimental fact that its characteristics are of the same form as those of the *n-p-n* but with all the positive signs changed to negative. Because of this, the characteristics are usually drawn upside down compared with Fig. 2. Because *all* the signs for voltage and currents are reversed, it follows that the same equations apply with the signs of all voltages and currents reversed, and so the equivalent circuit of Fig. 4 also applies to a *p-n-p* transistor if all voltages and directions of current flow are reversed.

It should be noted that the reversal of signs applies only to the currents and voltages. The quantities ρ_{11} , ρ_{22} , a and b still remain positive. Each of these terms is the quotient of a voltage by a current or the ratio of two currents and the quotient or ratio of two negative quantities is positive.

All this may be a little clearer from Fig. 5. Viewed as a whole, the diagram represents a resistance in series with a battery. The line $I_b = 0$ is for a resistance alone and is merely the graphical representation of a simple resistance. Inserting a battery in series with it to aid the external voltage V_c shifts the line upwards; inserting it to oppose the external voltage shifts it downwards.

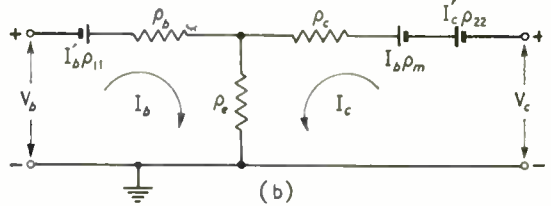
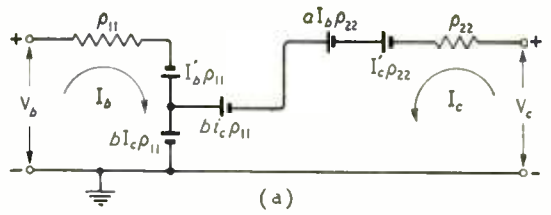

Fig. 6. This diagram illustrates the transformation of Fig. 4 into a different equivalent form. At (a) $bI_c\rho_{11}$ is made common to both base and collector circuits, but its effect in the latter is nullified by the extra battery of the same value opposing it. In (b) this common battery is replaced by a resistance ρ_e , the voltage being developed across it by the current through it.

The characteristics shown by full lines in the top right-hand quadrant are by themselves those of an ideal *n-p-n* transistor. Those in the bottom left-hand corner are those of an ideal *p-n-p* transistor. The dotted parts are non-existent for transistors. The whole diagram can be expressed by one equation which, using the transistor symbols, is

$$I_c = aI_b + V_c/\rho_{22}$$

For the *n-p-n* transistor V_c is positive and I_c is positive and only the top right-hand part of the diagram exists. Theoretically, I_b can then be negative as long as $aI_b < V_c/\rho_{22}$, but usually I_b is positive. For a *p-n-p* transistor, V_c and I_c are negative and only the bottom left-hand part of the diagram exists. Again, I_b can be of opposite sign and so positive, but it is usually negative.

One can see, however, quite clearly that ρ_{22} and a must be positive with both types of transistor for, with parallel straight lines, the values of these quantities are independent of the part of the diagram at which they are taken.

Reverting now to the equivalent circuit of Fig. 4, it is possible to transform this to a different arrangement of its parts which is sometimes convenient. The first step in doing this is shown in Fig. 6(a). The only changes that we have made here are to move the positive terminal of $aI_b\rho_{22}$ from earth to the junction of $I_b\rho_{11}$ and $bI_c\rho_{11}$ and to insert another battery $bI_c\rho_{11}$ in series with it. These make no difference, for the two batteries $bI_c\rho_{11}$ oppose each other in the collector circuit, so the positive terminal of $aI_b\rho_{22}$ is still at earth potential.

The next step is to replace the $bI_c\rho_{11}$ battery common to both circuits by a resistance and to arrange matters so that the voltage drop produced by the currents I_b and I_c produces the necessary e.m.f. The circuit then takes the form shown in Fig. 6(b). If (a) and (b) are to be identical, then all similar voltages and currents must always be the same for each. The conditions for identity are then easily found by writing the mesh equations and equating the coefficients of the same currents and voltages.

For Fig. 6(a) (or Fig. 4), we have for the first mesh

$$V_b = I_b \rho_{11} - I'_b \rho_{11} + b I_c \rho_{11}$$

and for Fig. 6(b) we have

$$V_b = I_b (\rho_b + \rho_e) - I'_b \rho_{11} + I_c \rho_e$$

Therefore, $\rho_{11} = \rho_b + \rho_e$ and $b \rho_{11} = \rho_e$.

For the second mesh we have for Fig. 6(a) (or Fig. 4)

$$V_c = I_c \rho_{22} - I'_c \rho_{22} - a I_b \rho_{22}$$

while for Fig. 6(b) we have

$$V_c = I_c (\rho_c + \rho_e) - I'_c \rho_{22} - I_b \rho_{22} + I_b \rho_e$$

hence $\rho_{22} = \rho_c + \rho_e$ and $a \rho_{22} = \rho_{22} - \rho_e$

Collecting these results, we find that for identity we must have

$$\rho_b = \rho_{11} - \rho_e; \quad \rho_e = b \rho_{11};$$

$$\rho_c = \rho_{22} - \rho_e; \quad \rho_{22} = a \rho_{22} + \rho_e$$

The resistance ρ_m may be a little confusing at first since it does not appear in Fig. 6 as a resistance. It is, perhaps, better to regard ρ_m as a multiplier for I_b which has the dimensions of a resistance and which when multiplied by I_b , gives the magnitude of the internal e.m.f. of the transistor.

The circuit of Fig. 6, like that of Fig. 4, represents the static characteristics of an *n-p-n* transistor in so far as the linear approximation to those characteristics is valid. The circuit for a *p-n-p* transistor is the same, but with the polarities of all voltages and the directions of all currents reversed.

The usual equivalent circuit is for a.c. conditions only and we could have derived this directly. However, some confusion between the two kinds of junction transistor is avoided if the d.c. equivalent circuit is first derived as a stepping stone, and we shall actually find a use later on for the d.c. circuit.

The first step in producing an a.c. equivalent circuit is to produce one which is valid for both d.c. and a.c. We can then get the a.c. one merely by taking away the d.c. part.

Hitherto, the circuits have been, strictly, d.c. ones and we obtain the combined a.c. and d.c. equivalents exactly as we did for the valve by letting each voltage or current be equal to the sum of a mean d.c. component and an a.c. component. Using the sub-

script "m" to denote this mean component and a small letter for the a.c. component, a voltage, say V_b , will become $V_{bm} + v_b$. In Fig. 4, therefore, we replace V_b by $V_{bm} + v_b$, I_b by $I_{bm} + i_b$, V_c by $V_{cm} + v_c$ and I_c by $I_{cm} + i_c$. The currents I'_b and I'_c are pure d.c. quantities and are not affected.

We can now draw the complete equivalent circuits for Fig. 1 as in Fig. 7 and these are valid for both d.c. and a.c. conditions within the limits imposed by the linear approximation. Notice that in both Figs. 1 and 7 the input voltage v_1 is of opposite polarity with respect to earth for the *p-n-p* transistor (b) compared with the *n-p-n* transistor (a). This is done for simplicity, so that the positive half-cycle of input voltage in both cases acts to assist E_b .

Exactly as we did with the valve, we can now drop all the d.c. terms from Fig. 7 to leave only the a.c. ones, and we then get Fig. 8. It is very important to notice that the two circuits (a) and (b) are essentially identical. All the voltage generators of (a) are reversed in polarity in (b) compared with (b), and so are all the directions of the currents. If, therefore, we reverse the polarity of v_1 in (b) so that it is positive

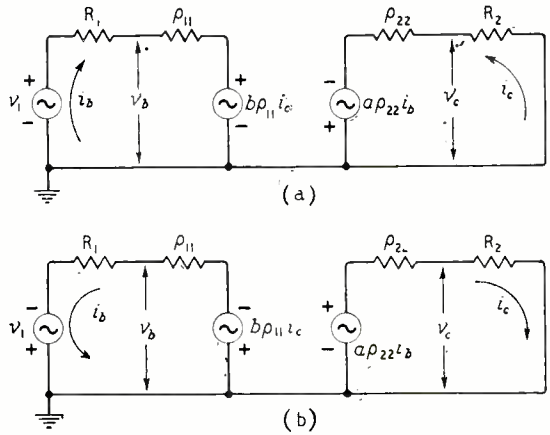

Fig. 8. The a.c. equivalent circuits of Fig. 1 are shown here. Since all voltages and currents in (b) are reversed as compared with (a), the two circuits are identical.

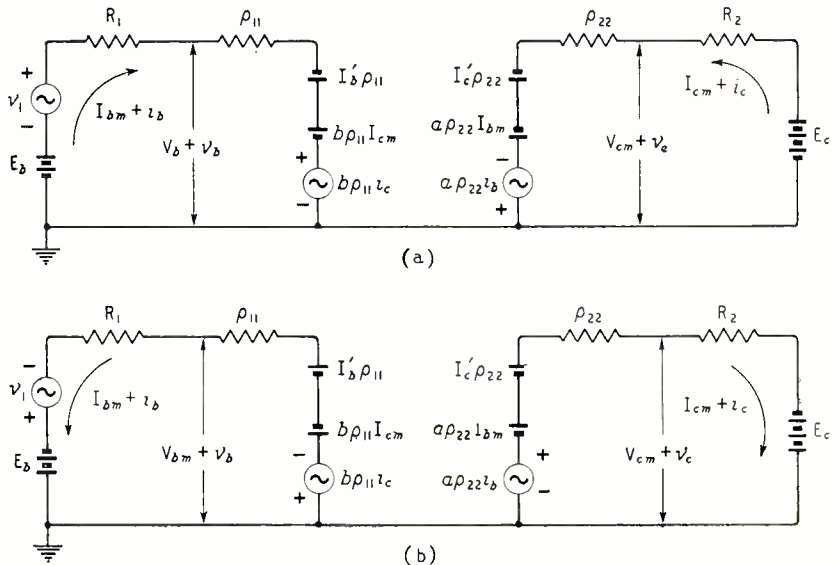

Fig. 7. The full a.c. and d.c. equivalent circuits of Fig. 1 are shown here for (a) an *n-p-n* transistor and (b) a *p-n-p* type. The a.c. inputs are of opposite polarity in the two.

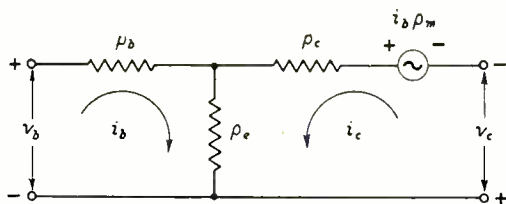

Fig. 9. An alternative equivalent circuit to that of Fig. 8 is shown here. This is the one most often used for the transistor.

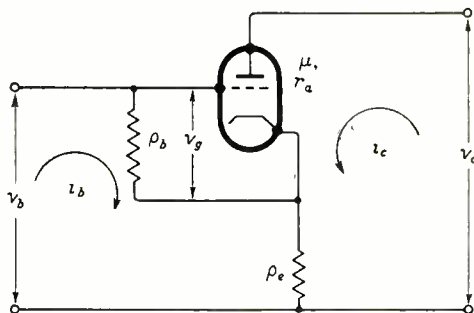

Fig. 10. A valve circuit which has an equivalent circuit the same as that of Fig. 8 and which, therefore, represents a transistor.

to earth as it is in (a), the direction of i_b must be reversed and this will reverse the polarity of the generator $a\rho_{22}i_b$ and hence the direction of i_c . In turn, the polarity of the generator $b\rho_{11}i_c$ will reverse.

It follows that the a.c. equivalent circuit is exactly the same for both $n-p-n$ and $p-n-p$ transistors.

This equivalent circuit can actually be used to represent, not only junction transistors, but any device whose characteristics can be expressed by two families of curves similar to Fig. 2. It can, therefore, also be used for the point-contact transistor (although it is not always easy to obtain these curves for this device) and for a positive-grid thermionic valve. For a negative-grid valve the grid current is zero, so ρ_{11} is infinite and b is zero; the left-hand half of Fig. 6 then disappears. The right-hand half forms the usual valve equivalent circuit if μv_g replaces $a i_b \rho_{22}$.

There are a great many alternatives to Fig. 8. Some of them are just ordinary circuit transformations of Fig. 8; others are similar but depend on other quantities than ρ_{11} , ρ_{22} , a and b for defining the transistor characteristics. A particularly common alternative to Fig. 8 is shown in Fig. 9; it is the a.c. version of Fig. 6(b). The relations between the two are easily obtained but, as the procedure is exactly the same as for the d.c. circuit and the relations so derived are the same, it is unnecessary to repeat it.

The form of equivalent circuit shown in Fig. 9 is actually the one most used in the literature, although it is usually derived for the earthed-base circuit rather than the earthed-emitter. Generally, the one of Fig. 8 is to be preferred because it leads to simpler design equations. The one of Fig. 9, however, has the merit that it is an obvious equivalent circuit of a thermionic valve plus a pair of resistances. In other words, a real valve circuit can be built which will simulate an earthed-emitter transistor.

In Fig. 9, the elements ρ_c and $i_b \rho_m$ are the same as the equivalent circuit of a valve if $\rho_c = r_a$ and $i_b \rho_m = \mu v_g$. If they are replaced by a valve, ρ_e becomes a cathode resistance and ρ_b a grid-cathode resistance

across which v_g is developed by i_b , so $v_g = i_b \rho_b$, and therefore, $\mu = \rho_m / \rho_b$. The circuit thus has the form shown in Fig. 10.

This circuit is a good one as an analogy for an $n-p-n$ transistor for its characteristics are obvious to anyone versed in valve circuits whereas those of a transistor are not so readily apparent.

It is instructive to insert some numerical values. A junction transistor may have $\rho_b = 750 \Omega$, $\rho_c = 45 \text{ k}\Omega$, $\rho_e = 35 \Omega$ and $\rho_m = 1.5 \text{ M}\Omega$. The equivalent valve may thus have a resistance of $45 \text{ k}\Omega$ which is quite feasible and a μ of $1,500,000/750 = 2,000$, which is rather impracticable, for it means a mutual conductance of $2,000/45 = 44.5 \text{ mA/V}$.

The transistor is thus equivalent to a superlatively good valve spoilt by a very low input resistance. It is so much spoilt, in fact, that the overall gain is no better than that of quite an ordinary valve.

So far, we have said little about the point-contact transistor. In fact, the same method of approach is possible and the same equivalent circuits are applicable. In practice, however, difficulties arise in obtaining characteristics of the same form as those of Fig. 2 because, in the earthed-emitter connection, the point-contact transistor can have negative input and output resistances. It needs careful use in this circuit if it is to be stable.

Because of this, it is usual to plot its characteristics for the earthed-base connection, in which it is inherently stable, and, because this is done for the point-contact transistor, it is quite common to do it also for the junction types. Transistor characteristics and constants are more often published for the earthed-base connection than for the earthed-emitter, however the transistor may be used. It is necessary, therefore, to consider the earthed-base transistor in some detail and this we shall do in Part 3.

(To be continued)

I.E.E. Awards to Authors

THE major premium of the Institution of Electrical Engineers for a paper read or accepted for publication during the last session—the Institution Premium (value £50)—is to be given to Dr. D. M. MacKay, of London University, author of "High-speed electronic-analogue computing techniques." The John Hopkinson premium (£25) goes to Dr. M. J. Kelly and G. W. Gilman (Bell Telephone Labs.) and Sir Gordon Radley and R. J. Halsey (G.P.O.), authors of the paper "A transatlantic telephone cable."

Dr. N. W. Lewis (G.P.O.) is awarded the Blumlein-Browne-Willans premium (£20) for his paper "Waveform responses of television links." The Fahie premium (£10) goes to J. M. C. Dukes (S.T.C.) for "The effect of severe amplitude limitation on certain types of random signal," and the Webber premium (£10) to W. E. Willshaw (G.E.C.), Dr. H. R. L. Lamont (R.C.A.) and E. M. Hickin (G.E.C.) for "Experimental equipment and techniques for a study of millimetre-wave propagation."

The premiums to be awarded for papers presented to the Radio Section are: Duddell (£20) to E. G. Rowe, P. Welch and W. W. Wright (S.T.C.) for "Thermionic valves of improved quality for Government and industrial purposes"; Ambrose Fleming (£10) to Dr. P. E. Axon, C. L. S. Gilford and D. E. L. Shorter (B.B.C.) for "Artificial reverberation"; a £10 premium to H. Page and G. D. Monteath (B.B.C.) for "Vertical radiation patterns of medium-wave broadcasting aeriels"; a £5 premium to M. W. Gough (Marconi's) for "Some features of v.h.f. tropospheric propagation," and another £5 premium jointly to R. C. Glass, G. D. Sims and A. G. Stainsby (G.E.C.) for "Noise in cut-off magnetrons."

Transmitting Colour Information

SIGNALLING TECHNIQUE IN THE BRITISH N.T.S.C. SYSTEM

MANY people are of the opinion that when a colour television system is finally adopted for this country it will be a version of the American N.T.S.C. compatible system, scaled down to fit British standards.* The ultimate choice of system largely depends, of course, on the recommendations of the Television Advisory Committee, and they will no doubt have several alternatives to consider when the time comes. One possible candidate, for example, could be the frame-sequential system and another the version of the N.T.S.C. system in which the colour information is transmitted in a different channel (or even band) from the brightness information. Be that as it may, the T.A.C. have already voiced the opinion (some may think quite wrongly) that British colour television ought to be compatible, which is as good as saying, in the present state of the art, that it ought to be something very much like the N.T.S.C. system, with the colour transmitted either inside or outside of the monochrome band. Undoubtedly this would be popular with the B.B.C., because it would involve very little change to their existing black-and-white transmitting equipment—only the addition of colour circuits. It may be significant, too, that the two major demonstrations

of colour television so far, by the rival firms Marconi and E.M.I., have both been using compatible systems.

On the assumption that a version of the N.T.S.C. system may well be adopted in Britain (and *Wireless World* is not necessarily in sympathy with the idea), it would perhaps be worth while looking at some of the aspects of the system which have not been fully explained in this journal so far. These are mostly to do with the processing of the colour information for transmission—a business which is quite significant in that it has some bearing on the design of domestic colour receivers. The transmission of the brightness information is not so important because it is virtually the same as the transmission of black-and-white pictures in our existing system—and in fact the brightness channel of colour receivers would look very much like the whole of the present monochrome receivers.

Wireless World has already explained the basic principles of the N.T.S.C. type of system* but it may be as well to recapitulate some of the characteristic features. At the transmitting end the colour information from the colour camera is separated into two main components, a signal conveying the brightness information of the picture and a signal

* See for example "Colour Television on 405 Lines" *Wireless World*, June, 1954

* "American Colour Television," *Wireless World*, November, 1953

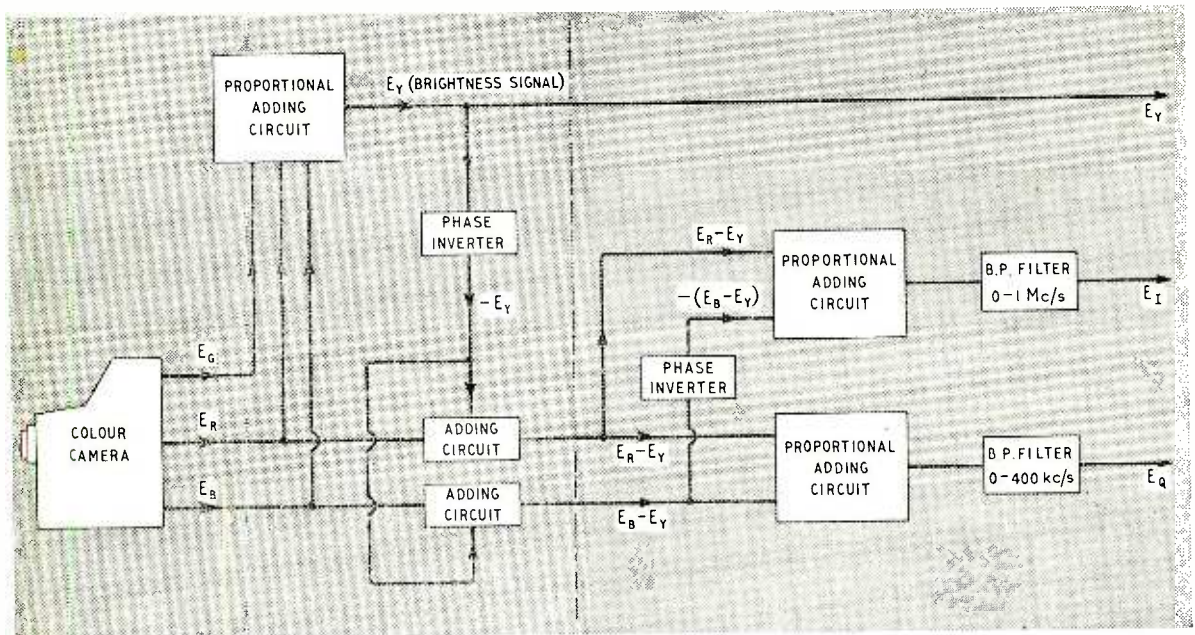

Fig. 1. Block schematic (very simplified) of the transmitting end of the British N.T.S.C. system. The section to the right of the broken line contains the circuits for producing the modified colour-difference signals from the original ones (to the left of the line)

carrying the colour information (i.e. hue and saturation). The brightness signal is received on existing monochrome television sets as a black-and-white picture, while in colour receivers it is recombined with the colour signal to produce a complete colour picture. We explained how the colour information was produced in the form of two colour-difference signals, $E_R - E_Y$ and $E_B - E_Y$ (as shown on the left of Fig. 1), which were transmitted as amplitude modulation on two components of a sub-carrier having a phase difference of 90° between them. The two components were combined, as shown by the vector diagram Fig. 2(a), to produce a single colour signal which carried hue information by phase modulation and saturation information by amplitude modulation. (Fig. 2(b) shows the various phase angles of the colour signal and the colours which they represent.) The sub-carrier was actually suppressed and the remaining sidebands were transmitted within the same band as the brightness signal by a process of frequency interleaving.

This description was actually of an early version of the N.T.S.C. system. The system which is now being used is basically the same, but the two colour-difference signals have been slightly modified. They are now each composed of certain proportions of *both* of the original colour-difference signals. These proportions are arranged so that one modified colour-difference signal conveys colour information ranging from orange to bluish-green (cyan) and the other colour information ranging from yellowish-green to purple. In the British version of the N.T.S.C. system* the orange-cyan signal is allowed a bandwidth of about 1 Mc/s while the yellowish-green-purple signal is restricted to about 400 kc/s.

Human Colour Vision

This modification to the system is actually a method of processing the colour information which takes advantage of the limitations of the eye's colour vision to secure the best possible transmission conditions within the limitations of the signalling channel. Our November 1953 article on the N.T.S.C. system has already explained that the human eye is insensitive to colour in very fine detail and only perceives it in the form of brightness changes. The N.T.S.C. system therefore does not transmit the very fine detail of the picture through the colour channel, but leaves it to the brightness channel, which has the full 3-Mc/s bandwidth available to handle it. With very coarse detail the eye is able to perceive the colours properly, but as the coarse detail is represented by a video signal of low information-content the bandwidth of the colour channel here can be quite small—in fact about 400 kc/s.

In between these two extremes there is a grade of moderately fine picture detail where the eye is only partly effective in its colour perception. It is aware of the existence of colours but cannot distinguish between them properly—in fact it is partly colour-blind. For example, blue and yellow are confused with grey, brown is difficult to distinguish from crimson, and blue is confused with green. Reddish colours, however, remain clearly distinct from blue-greenish colours, and, in fact, the eye tends to interpret all other colours in terms of these two opposites, or mixtures of them. With this moder-

ately fine grade of picture detail, then, colour vision degenerates from being a three-colour process to a two-colour process.

The effect can be illustrated in graphical form on the well-known Maxwell colour triangle, Fig. 3. Here the three primary colours are at the three corners, while other colours produced from mixtures of them can be specified by the spatial positions of points within the triangle. With two-colour vision, this diagram becomes nothing more than a straight line, as shown, running from orange to cyan across the original triangle. All possible colours in this two-colour system can then be specified by distances along the line instead of by spatial positions within the two-dimensional diagram. (It is interesting to note that orange and cyan are the two basic colours which have been found by experience to give the best approximation to reality in two-colour photography.)

The orange-cyan line, then, represents the "working characteristic" of the eye on colour detail of medium fineness. In the British N.T.S.C. system this particular grade of detail is represented by a band of video frequencies of up to about 1 Mc/s. The transmission circuitry is therefore arranged so that colours in the orange-cyan range are conveyed by a particular signal—the modified colour-difference signal, as mentioned above—which is, in fact, allowed this 1-Mc/s bandwidth. The other modified colour-difference signal conveys the remaining range of colours, yellowish-green to purple (also shown in Fig. 3) which, when combined with the orange-cyan range, give complete three-colour reproduction. But as the eye is only sensitive to three-colour reproduction in very coarse detail it is possible to transmit this yellowish-green to purple signal with quite a narrow bandwidth, in fact about 400 kc/s. Thus, considering the system as a whole, one can see that the transmitted picture information is divided into three categories—coarse picture detail (up to 400 kc/s) which is transmitted in full colour; moderately fine detail (up to 1 Mc/s), transmitted in two colours; and very fine detail (up to 3 Mc/s) which is only transmitted as brightness changes as in an ordinary monochrome system.

The actual method of producing the modified colour-difference signals can be seen from Fig. 1. In the first place, the brightness signal, E_Y , which provides the black-and-white picture for existing receivers, is formed by adding together certain proportions of all three primary-colour-component signals from the camera. The colour difference signals $E_R - E_Y$ and $E_B - E_Y$ are obtained, as explained in the November 1953 article, by adding a phase-inverted version of E_Y (that is $-E_Y$) to E_R and E_B , the purpose being to remove the redundant brightness information which exists in E_R and E_B . Green is not transmitted separately because it can be obtained at the receiver by subtracting the sum of the red and blue signals from the brightness (or "white") signal.

More adding circuits are now brought into play to form the modified colour-difference signals from the original ones. First of all the orange-cyan signal. To produce this, 74% of $E_R - E_Y$ is added to 27% of a negative quantity, $-(E_B - E_Y)$, which is obtained by a phase inverter from the positive $E_B - E_Y$ signal. This $-(E_B - E_Y)$ signal in fact represents the opposite or complementary colour of blue, which is yellow, and one can see that 27% of yellow added to 74% of red

* "Colour Television on 405 Lines," *Wireless World*, June, 1954.

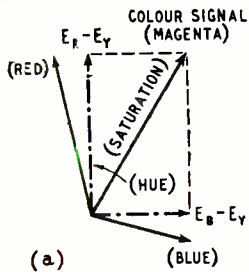

Fig. 2 (a). Vector diagram showing how, in the earlier N.T.S.C. system, the colour signal was produced from two colour-difference signals. In (b) are some of the phase angles taken up by the colour signal and the colours they represent. (Red is displaced from $E_R - E_Y$ because it is a resultant of $E_R - E_Y$ and $E_B - E_Y$ and although E_B is zero the $-E_Y$ makes $E_B - E_Y$ into a minus quantity.)

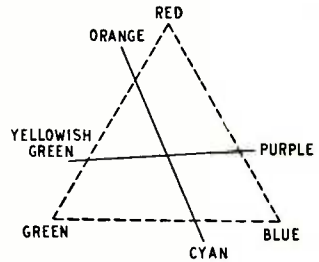
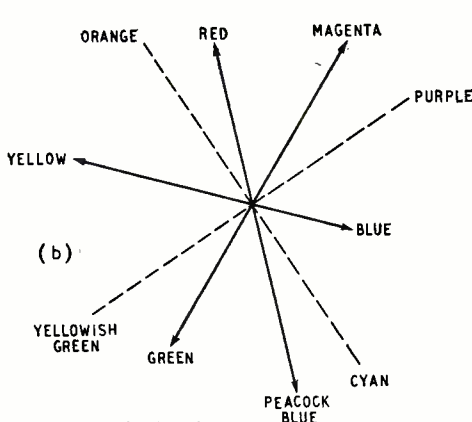

Fig. 3. Maxwell colour triangle with two axes showing the ranges of colours transmitted by the two modified colour-difference signals E_I and E_Q .

will produce orange. Thus the modified colour-difference signal coming out of the adding circuit now represents the orange in the picture (or colours seen as orange) directly, whereas before it was conveyed indirectly by two separate components in the $E_R - E_Y$ and $E_B - E_Y$ primary colour channels.

It is easy to see that yellow and red added together will produce orange, but what about the cyan end of the "working characteristic" in Fig. 3? When colours in this part of the spectrum (or colours which the eye interprets as cyan) appear in the picture $E_R - E_Y$ becomes a negative quantity $-(E_R - E_Y)$, which represents the opposite of red, or peacock blue, while the $-(E_B - E_Y)$ goes back to positive, which of course represents blue. The added proportions of the two then produce cyan, which lies between blue and peacock blue on the colour triangle. In other words, the colour signal vector which represented orange in the first instance, at "11 o'clock" in Fig. 2(b) undergoes a 180° change of phase and appears at "5 o'clock" between blue and peacock blue. For the other modified colour-difference signal (yellowish-green to purple) the two constituents are 41% of $E_B - E_Y$ plus 48% of $E_R - E_Y$. When these values are positive they add to give the purple ("2 o'clock" on Fig. 2 (b)) and when they are negative they give the yellowish-green ("8 o'clock" on Fig. 2 (b)).

After the two signals are formed they are passed through band-pass filters as shown. The result is that both of them are effective and give three-colour reproduction for video frequencies up to 400 kc/s (coarse picture detail), while at video frequencies between 400 kc/s and 1 Mc/s (moderately fine detail) only the orange-cyan signal is transmitted, giving the two-colour reproduction to which the eye is physiologically restricted in this range. As was mentioned above, the two colour-difference signals in the earlier N.T.S.C. system were transmitted by being modulated on to two components of a sub-carrier, displaced 90° in phase, which were then combined to form a single r.f. signal (Fig. 2 (a)). The modified colour-difference signals in the British system are handled in exactly the same way, the orange-cyan signal being designated E_I and the yellowish-green to purple signal E_Q .

At this point one might be inclined to ask: why bother to restrict the E_Q signal to about 400 kc/s bandwidth when the E_I signal is already causing the

final r.f. colour signal to take up a full 1 Mc/s? The answer to this is bound up with the problem of avoiding mutual interference and cross-talk between the various component signals in the complete transmission channel (see Fig. 4).

First of all it is essential that the colour signal, which is transmitted within the same 3-Mc/s band as the brightness signal, shall have minimum visibility on the screens of black-and-white receivers. One of the expedients necessary to achieve this is to make the colour sub-carrier frequency as high as possible so that the pattern it produces on the screen will have a very fine structure. Now with a high sub-carrier frequency, placed well to the right as in Fig. 4, it is clearly only possible to transmit the lower sidebands of a 1-Mc/s colour signal in full, the upper sidebands being partly removed by the upper limit of the 3-Mc/s pass band. If both E_I and E_Q were given the full 1-Mc/s bandwidth they would both have sidebands like E_I in Fig. 4. Transmission of these two signals on the same sub-carrier would be satisfactory over the small band where double-sideband operation is possible, but beyond this point the missing upper sidebands would have the effect of introducing spurious signals into the E_I channel from the E_Q channel and vice versa. The result on the receiver screen would then be incorrect colour reproduction at the edges of objects.

Overcoming Colour Cross-Talk

By restricting the E_Q signal to a bandwidth of about 400 kc/s, however, this cross-talk problem is overcome, simply because over the range where E_I consists only of single (lower) sidebands (400 kc/s to 1 Mc/s), there is no E_Q signal for it to interfere with. In other words, the two colour-difference signals E_I and E_Q are transmitted together on the same sub-carrier only in the video frequency range where double-sideband operation is possible for both, and consequently no interference occurs between them. The sub-carrier frequency is positioned so that this d.s.b. range is big enough to accommodate the band of video frequencies for which three-colour reproduction is effective. Beyond 400 kc/s a single colour-difference signal is transmitted, E_I , in the form of a set of lower sidebands, and only this one signal is necessary because the viewer's eye cannot perceive anything more than the two-colour information which it conveys. In the British N.T.S.C. system the sub-carrier is placed at 2.66 Mc/s, and

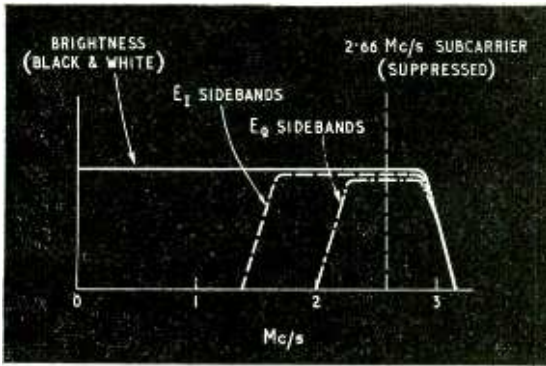

Fig. 4. Frequency characteristic of the 3-Mc/s vision channel of the British N.T.S.C. system, showing how the sub-carrier and its sidebands carrying the colour information are placed relative to the upper limit of the pass band.

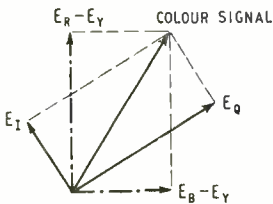

Fig. 5. Vector diagram of the E_I and E_Q signals and their resultant colour signal, showing how the colour signal vector can also be separated into components equivalent to $E_R - E_Y$ and $E_B - E_Y$. The angles taken up by the colour signal vector with the various colours are the same as in Fig. 2 (b).

this represents a compromise between two conflicting requirements—mitigating the interference pattern on the screens of black-and-white receivers and avoiding colour cross-talk.

Colour information in the British N.T.S.C. system, then (as in the American system), is transmitted not in terms of the well-known primary colours red, green and blue, but by another group of colours which are more suited to the characteristics of the signalling channel (including the human eye). In the earlier system the red, green and blue primary-colour information was converted into two colour-difference signals which were finally combined into a complete colour signal; this represented the hue of the colour by its phase angle and the saturation by its amplitude. The modified primaries in the later system are also transmitted as colour-difference signals in a similar fashion and the transmitted colour signal has the same phase angle and amplitude as before for a given hue and saturation—that is, for video frequencies up to about 400 kc/s. Between 400 kc/s and 1 Mc/s only one of the modified colour-difference signals is in operation, giving two-colour reproduction along the orange-cyan line in Figs. 2(b) and 3. The vector representing the transmitted colour signal then does not rotate through all the positions shown in Fig. 2(b), but rises and falls along the line marked ORANGE-CYAN (in both positive and negative directions).

As far as the receiver is concerned, then, it is presented with a colour signal which is modulated in both phase and amplitude, and from these modulations the original colour information has to be recovered. The technique usually adopted makes use of synchronous detectors. The incoming sidebands are mixed with two local oscillations which have the same frequency as the colour sub-carrier but are displaced 90° in phase (as at the transmitting end).

One mixer then recovers the E_I signal as a product while the other recovers the E_Q signal, and from these the original E_R , E_B and E_G primary-colour-component signals are eventually obtained.

It is important, however, that the two local oscillations shall have the same phases as the two sub-carrier components at the transmitting end, otherwise they will not recover the E_I and E_Q signals but something else. The point is illustrated by the vector diagram Fig. 5, which shows the final colour signal and the E_I and E_Q signals from which it is composed. Here, as in Fig. 2(a), the colour signal vector is a resultant formed by the two component vectors E_I and E_Q , and these component vectors indicate the phases which the oscillators at the receiving end must have if E_I and E_Q are to be recovered. It is clear, however, that the resultant vector can be separated into many other pairs of components, apart from E_I and E_Q , all having the 90° phase displacement between them. In practice this can be done at the receiver by altering the phases of the two synchronous-detector oscillators—and, in fact, these phases can be shifted so that the detectors recover not E_I and E_Q but two components equivalent to $E_R - E_Y$ and $E_B - E_Y$ in Fig. 1, the original colour-difference signals.

Thus, at the receiving end, the colour information can be obtained in two different forms, either as E_I and E_Q signals giving wide-band colour information, or as $E_R - E_Y$ and $E_B - E_Y$ signals giving narrow-band colour information. The advantage to be gained by recovering the narrow-band signals is simplicity of receiver design and hence cheapness in manufacture, and most of the present American receivers are, in fact, using this system. Moreover, R.C.A. in America have recently produced an improved colour demodulator for their receivers which not only recovers the $E_R - E_Y$ and $E_B - E_Y$ signals but the $E_G - E_Y$ signal as well, and also gives enough output to drive the tri-colour c.r. tube directly. It uses only one double valve and is undoubtedly a great advance in circuit simplification. At the same time, of course, this type of operation will not give the high-definition colour reproduction that can be obtained by using more elaborate circuitry to recover the E_I and E_Q signals. However, if the colour information is transmitted in the way described above it will be possible to use the cheaper receivers (a real necessity for this country) and at the same time leave the door open for more complex receivers giving better colour reproduction if they are ever wanted.

Broadcast Receiver Sales

AMENDED figures for the sale of broadcast receivers in April (see p. 346, July) have now been issued by the British Radio Equipment Manufacturers' Association, together with the figures for May. It will be seen from the table that the retail sales of television receivers in May dropped by 11,000 (15%) compared with the previous month and by nearly 40% compared with the January figure.

	Sound	Radiograms	Television
January	98,000	35,000	103,000
February	99,000	33,000	98,000
March	95,000	24,000	85,000
April	79,000	16,000	75,000
May	73,000	15,000	64,000

THE CASCODE

By "CATHODE RAY"

—And Its Advantages for Band-III Reception

THE present seems an appropriate time to say something about the cascode, because although it is not at all new it has only just begun to be sold to the public. In fact, the said public, as a class, are still blissfully unaware of the infiltration of cascades into the privacy of the home. All they know is that they are foresightedly taking steps to re-establish the ascendancy over the Jones's that they lost when the Jones's too installed television. These steps consist either in buying a new model fitted for Band III, or a box of tricks to adapt their present model; and they hope that, by the time the Jones's realize that advertisement TV has actually begun, the waiting list for equipment to enable it to be seen will be very long. But foresightedly though they may be, unless they are technically minded they still won't realize that they have bought a cascode.

Wireless World readers, however, may be more interested in the why and how of the cascode than in knowing which washing powder makes that dainty woolly newer than new.

The name "cascode" dates from before the war,* and may perhaps be regarded as an abbreviated form of "casc(aded)-triode amplifier having characteristics similar to, but less noisy than, a single pent(ode)." But that original arrangement was slightly different from the present form† and was devised for an altogether different purpose, at the extreme opposite end of the frequency scale—zero and thereabouts. The cascode has also been highly recommended for audio frequencies.† So altogether it is a versatile creature, and we ought to know something about it.

Fig. 1 shows a cascode arranged as a resistance-coupled low-frequency voltage amplifier. Essentially the same circuit could be used as the amplifier in a voltage-stabilized power unit. Fig. 2 shows a cascode arranged as a v.h.f. amplifier in a Band-III television receiver or adapter. There are all sorts of variations on the same theme, so the first thing we want to settle is the basic theme itself—the minimum that constitutes a cascode.

The short answer is: two stages of amplification, comprising an earthed-cathode triode, cascade-connected to an earthed-grid triode. But perhaps that answer itself needs a little amplification.

First of all, "cascade-connected." That means connected one after the other, as distinct from valves in push-pull and parallel stages, which come two at a time. It is not—in spite of the appearance of Fig. 1—quite the same thing as series connection. In cascade connection, which is the usual way of connecting successive valves in an amplifier, the output of the first provides the input of the second.

Now there are three basic ways of connecting a

single valve to make a stage of amplification. These ways can conveniently be named according to the electrode that is earthed; the other two electrodes are those used for input and output respectively. The commonest arrangement of the three is the earthed-cathode, in which the input is led to the grid and the output taken from the anode. The next commonest is the earthed-anode, better known as the cathode follower. It, too, has the input connected to the grid, but the output from the cathode. Lastly, the earthed-grid (called by crypto-Americans

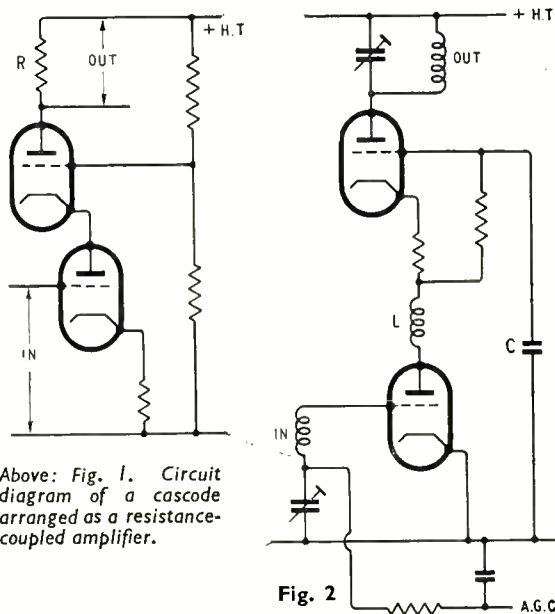

Above: Fig. 1. Circuit diagram of a cascode arranged as a resistance-coupled amplifier.

Fig. 2

Above right: Fig. 2. Circuit diagram of a cascode arranged as a v.h.f. amplifier, say for Band III television.

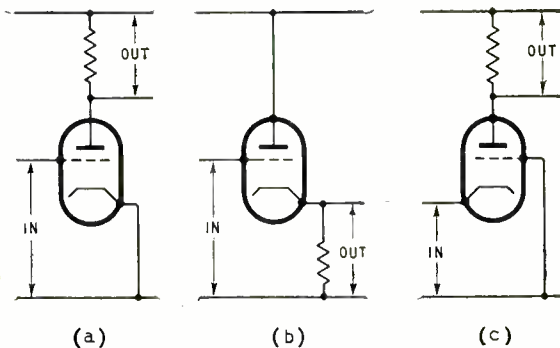

Fig. 3. Essentials of the three ways of connecting a triode as a stage of amplification: (a) earthed cathode; (b) earthed anode; (c) earthed grid.

* "Electronic Voltage Stabilisers," by Hunt and Hickman, *Rev. Sci. Inst.* Jan. 1939, p. 6.

† "A Low-noise Amplifier," by Wallman, Macnee and Godsden, *Proc. I.R.E.*, June 1948, p. 700.

‡ "Cascode Audio Amplifier has Low Noise Level," by R. L. Price, *Electronics*, March 1954, p. 156.

“grounded-grid”), in which the grid (however did you guess?) is earthed, the input goes to the cathode, and the output comes from the anode. Fig. 3 lines up these three, stripped of all practical details, for inspection.

In a two-valve cascade-connected amplifier, the first stage can be connected in any of these three ways. Each of these three varieties can be subdivided into three, according to the way the second stage is connected. So altogether there are nine possible combinations. When this fact first dawned on my consciousness, I supposed that most of the combinations would be of purely academic interest, only two of three being used in practice; but on going steadily through the lot I found that most, if not all, had been used at some time, for some purpose. For instance, did you know that there was actually a special type of valve—the 6B5—embodying the earthed-anode earthed-cathode combination? Then the earthed-anode earthed-grid combination is the basis of the well-known coupled-cathode or “long-tailed pair,” used in many valve voltmeters and oscilloscopes. The earthed-grid earthed-cathode is used in radar and other v.h.f. receivers. But however interesting it might be to explore all nine, the only one on to-day’s schedule is, as already mentioned, the earthed-cathode earthed-grid combination.

Coupling Impedance

You will of course want to know why anybody should choose this in preference to the earthed-cathode earthed-cathode, which gives easily the most amplification of any of the nine. But before going into that, let us just make sure that Figs. 1 and 2 really are earthed-cathode earthed-grid cascade combinations and not just the valves connected in series that they appear to be. Looking again at Fig. 3 we see that all three circuits include a resistor (or some other kind of impedance) which performs two roles: providing a path for the steady feed current through the valve, and by its impedance causing the signal current to set up a signal output voltage. This output voltage can then be applied to the input of a following stage. If this following stage is of either the (a) or (b) types, the coupling impedance is still required for the first stage; but type (c) is unique, because not only do its input terminals provide an impedance across which the input voltage can be set up, but the cathode terminal in particular also provides a source of feed current for the first stage. So the coupling impedance can be omitted.

As drawn in Fig. 1, the second or upper valve appears most clearly in its role of coupling impedance and steady-current feeder, corresponding to the resistor in Fig. 3(a). To emphasize its other role of second stage in a two-valve amplifier, I have redrawn Fig. 1 as in Fig. 4. It is now clearly the same as in Fig. 3(c), the only apparent difference being the point to which the grid is connected; and that is the same in principle, being equivalent to earth even though, in order to bias the grid suitably relative to its cathode, it is taken to a source of positive potential. Fig. 4, although its circuit is identical with Fig. 1’s, shows more clearly that, while the second valve is in series with the first for current-feed purposes, it is truly in cascade as regards signal amplification.

And now we come to the question of why this arrangement should ever be preferred to the more highly amplifying all-earthed-cathode system. The

answer depends on which of the two main applications we have in mind. The chances just now are heavily in favour of Band III being in mind, rather than voltage stabilizers, though we’ll come to them too in due course.

At the very high frequencies of Band III it is difficult to generate such massive power for transmitting as on the lower frequencies. The waves, when transmitted, are more rapidly attenuated; and the receiving aerials are necessarily short and therefore limited in collecting ability. So the signal voltage, or rather microvoltage, that can be brought to the input of a receiver is likely to be very small. At the same time it must, for television, be spread over a wide frequency band and so has to compete with a lot of noise of the kind self-generated in circuits and valves. In fact, even though v.h.f. isn’t too easy to amplify, the limit is not set by that difficulty so much as by the signal-to-noise ratio that can be achieved. If the signal doesn’t succeed at the outset in poking its head high enough above this noise, no amount of subsequent amplification will help it, because the noise is amplified too. So all depends on the first stage of amplification, in which the signal is at its weakest.

Because of the greater difficulties of amplifying v.h.f. signals, there is an obvious inducement to change to a lower frequency as soon as possible. But a frequency-changer stage is at best a comparatively noisy affair, so doesn’t make at all a suitable first stage for signals that are already barely strong enough to stand clear of noise. A preliminary stage of amplification, even if it doesn’t give very much, and even if it introduces some noise itself, helps the signal to master the greater frequency-changer noise. In case this point is not entirely obvious, let us suppose that a certain frequency changer introduces $6\mu\text{V}$ of noise and neither amplification nor loss, and that a stage of amplification introduces five-fold voltage gain and the equivalent of $3\mu\text{V}$ of noise at its input. If the incoming signal is $16\mu\text{V}$, together with $2\mu\text{V}$ noise, the incoming signal/noise voltage ratio is 8 : 1 and its power ratio 64 : 1. After the frequency changer alone the signal would still be $16\mu\text{V}$ and the noise voltage $\sqrt{(2^2 + 6^2)} = 6.3^*$, so the signal/noise power ratio would be degraded to 6.5 : 1. But if the amplifier were used first, its output would include $5 \times 16 = 80\mu\text{V}$ of signal and $5\sqrt{(2^2 + 3^2)} = 18\mu\text{V}$ of noise (nearly 20 : 1 power ratio), and the output of the frequency changer following would be $80\mu\text{V}$ signal and $\sqrt{(18^2 + 6^2)} = 19\mu\text{V}$ noise, making the ratio 18 : 1. This simplified example shows how even a moderate amplification, itself not noiseless, can much improve the net result.

What Valve to Use

Having decided to use at least one stage of amplification at the original frequency, we are then faced with conflicting claims in the choice of amplifier. A r.f. pentode has internal screening which helps to prevent feedback via stray capacitance turning the amplifier into an oscillator, as would inevitably happen with an earthed-cathode triode owing to its anode-to-grid capacitance. On the other hand, a pentode is a good deal noisier than a triode. I went into detail about this noise business in the May and June 1952 issues, so for present purposes it should be enough

* Noise voltages, like a.c. voltages of unequal frequency, have to be added together in this way; see “Total Power” in the March 1952 issue.

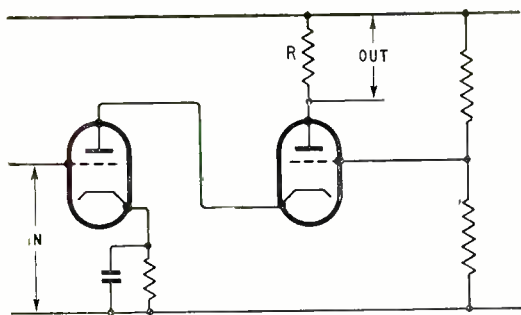

Fig. 4. Rearrangement of Fig. 1 to show more clearly the role of the second valve as an earthed-grid stage.

to say that because the current through a valve consists of separate electrons there is bound to be a small random fluctuation around even the steadiest average, and it is this fluctuation that is referred to as noise. In a pentode the fluctuation is greater than in a triode, because on top of this chance of slightly fewer or more electrons arriving during any instant, there is the chance of whether any particular electron will be intercepted by the second grid or go right on to the anode. Though you might not think so, this extra chanciness adds very considerably to the noise. The average for 10 different kinds of pentodes used for amplification showed 75% greater noise voltage than the average for a number of triodes. So there is a strong inducement to use a triode, if it can be made to amplify at v.h.f.

As we know, it cannot if it is simply connected in the usual earthed-cathode manner. This is where the earthed-grid triode came in, especially during the last world war for 200-Mc/s radar. Unfortunately an earthed-grid triode presents a very low input impedance, even by v.h.f. standards. As we see from Fig. 3(c), it is not much more than the *output* impedance of a cathode follower, and we know that that is very low—approximately $1/g_m$, or say 200 Ω if g_m , the “slope” of the valve, is 5mA/V. The only difference between this circuit and a cathode follower is the external anode resistance, which reduces the overall slope by adding to the internal anode resistance, r_a . In a v.h.f. amplifier, the external resistance is the dynamic resistance of a tuned circuit, and is likely to be considerably smaller than r_a . So the input resistance is still very low, and establishing a signal voltage across it costs plenty of signal power. Stage gain is therefore even less than usual for a triode.

The attraction of the cascode is that it combines the low noise of a triode with earthed-cathode input resistance and the high gain and stability of a pentode. And although the circuit diagrams here make it look as if two valves were being used in place of one, in practice the two triodes take the form of one double triode costing about the same as one pentode and occupying the same space and valve-holderage.

The second half of the cascode is an earthed-grid stage as just described, and its low input resistance constitutes the anode load or coupling resistance (R_a) of the first half. So although this first half is an earthed-cathode stage, it is prevented from bursting into oscillation by the fact that its R_a is too low to give enough amplification. When the R_a of a voltage amplifier is much smaller than the r_a of the valve, the voltage amplification (A) is approximately equal

to $R_a g_m$. But in this case we know that R_a is approximately equal to $1/g'_m$, where g'_m is the slope of the second triode, as modified by its anode load. So the amplification of the first stage is

$$A \approx R_a g_m \approx \frac{g_m}{g'_m}$$

The slopes of the two valves in a double triode are (or should be) more or less equal. So even if the load resistance of the second were as much as equal to r_a , g'_m would be half g_m , and A consequently no more than 2. In practice, at v.h.f., it would probably be nearer 1. This doesn't mean that the first stage contributes next to nothing; its real job is to drive the second stage without damping down the input circuit or introducing a lot of noise. It functions, in fact, very like a cathode follower.

The output of the second stage is quite conventional. Fig. 2 shows the whole cascode as arranged for Band-III amplification. Instead of being taken to a tapping on a potential divider, the grid of stage 2 has conventional bias arrangements, but at signal frequency is tied down to earth by C. This modification of Fig. 1 enables automatic gain control to be applied in the customary manner to stage 1. In Fig. 1, a.g.c. bias would be almost completely ineffective in changing the anode current and with it the amplification, because the fixed potential of grid 2 would tend to hold it constant. The only other thing that might perhaps excite curiosity about Fig. 2 is L. Its purpose is to neutralize stray capacitance at the top frequency of Band III, where there would otherwise be a falling off in amplification.

Mathematical Approach

If, as I hope, you like to work things out mathematically for yourself, I can recommend analysing Fig. 1 by writing down the equations—five of them—expressing overall voltage amplification, A; signal anode current, i_a ; signal voltages of the two anodes, v_{a1} and v_{a2} ; and signal voltage between second grid and cathode, v_{g2} ; in terms of the μ and r_a of the two valves, the signal voltage v_{g1} applied to the first grid, and R. If the valves are *not* assumed to be identical, the answer should come out to

$$A = \frac{(\mu_2 + 1) \mu_1 R}{R + r_{a2} + (\mu_2 + 1) r_{a1}} \dots \dots (1)$$

If the valves *are* identical this simplifies to

$$A = \frac{(\mu + 1) \mu R}{R + (\mu + 2) r_a}$$

while if μ is large enough for the difference between it and $\mu + 2$ to be neglected,

$$A \approx \frac{\mu R}{R/\mu + r_a}$$

which compares with

$$A = \frac{\mu R}{R + r_a}$$

in a conventional single-triode amplifier. These results prove what we have already gathered, that the v.h.f. amplification of the cascode as a whole is not noticeably greater than would be given by one of its valves connected as an ordinary stage *if there were no such thing as Miller effect to upset its working*. But there is, and the addition of the second triode overcomes it without having to fall back on the noisy pentode.

Looking at things from different viewpoints is usually a help in understanding them; and having

considered the cascode as two successive conventional stages in an amplifier, we may now care to think of it as a single unconventional stage. The difference between pentode and triode characteristics can be expressed in one way by saying that the pentode has a very much larger internal resistance r_{a1} , which is the same thing as saying that its anode current is very little affected by its anode voltage. Putting a load resistance in series with the anode therefore has hardly any effect on the amount of anode current. This is not so with a triode, however. When its anode current is increased by making the grid less negative, any anode load resistance causes the anode voltage to drop, and this cuts down the increase that would otherwise have taken place.

With this in mind, consider Fig. 1 again. The first (lower) valve has an anode load resistance consisting of the other valve plus R . If the grid of this other valve had a fixed bias relative to its cathode, the action would be as just described. But because the grid is tied to a fixed potential, the drop in cathode potential caused by any increase in anode current is equivalent to making the grid less negative, which operates to maintain the increase in anode current. Since the cathode potential cannot alter much without drastically altering the anode current in this way, it tends to stay nearly constant. This is the same

thing as the lower valve's anode voltage staying nearly constant, regardless of changes in anode current induced by changes in its grid voltage. So the system as a whole behaves something like a pentode, in two ways: the anode current has been made to depend almost exclusively on the voltage of the first grid regardless of the presence or absence of R ; and the potential of the electrode next to that grid—the first anode—has been made to stay nearly constant, and so to simulate the screen grid in a pentode, which keeps the amplifier stable.

Voltage Stabilizer Application

There is no reason, of course, why the cascode cannot be used at lower radio frequencies than v.h.f., or even audio frequencies, but amplification of lower r.f. is not usually limited by valve noise, and a pentode gives more amplification. For a.f. it is an interesting question whether, on balance, the cascode is better than the two valves of a double triode connected in the ordinary way as two earthed-cathode stages. Coming at last to the amplifier used in the usual type of voltage stabilizer, there is much more to be said for the cascode. Most of it has been said very well by V. H. Attree,* who has devised a modification that looks like establishing the cascode as undisputed king of this situation.

Just to make sure that we are both thinking about the same "usual type of voltage stabilizer," Fig. 5 is an outline diagram, for identification, in which V_1 is the amplifier in question. The greater the amplification of this stage, the more effective the stabilizer. So the choice of valve is almost invariably a pentode. To extract a reasonable proportion of the valve's potential amplification, the resistance R must be large. But the voltage across it, being the bias for V_2 , is normally quite small, which means that the valve is working under conditions (to wit, low g_m) that throttle most of its amplification. If two stages were used, the output voltage would be of the wrong polarity and the stabilizer would become an un-stabilizer. Two stages, that is to say, connected in the usual earthed-cathode manner. But this difficulty does not apply to the cascode, because its second stage, being earthed-grid, does not reverse the polarity. The criticisms that have just been made about the pentode would go for the cascode too, if it were as per Fig. 1. But Mr. Attree has pointed out that when μ_1 and μ_2 in our equation (1) are large (because a high- μ double-triode has been chosen), and R and r_{a2} are neglected in comparison with μr_{a1} , the thing reduces to

$$A \simeq \frac{\mu_1 R}{r_{a1}} = g_{m1} R$$

So the amplification depends hardly at all on the g_m of the second triode and almost entirely on that of the first, and it doesn't matter if the current through R and the second valve is small, so long as it is large enough for a good big g_m in the first. The modification therefore consists of an extra resistor to pass more current through this valve.

The circuit (less all frills) is as Fig. 6. With this improvement, the voltage amplification of the cascode can easily be well over 1,000, which makes the stabilizer incorporating it a very good stabilizer.

* "A Cascode Amplifier Degenerative Stabilizer," *Electronic Engineering*, April 1955, p. 174.

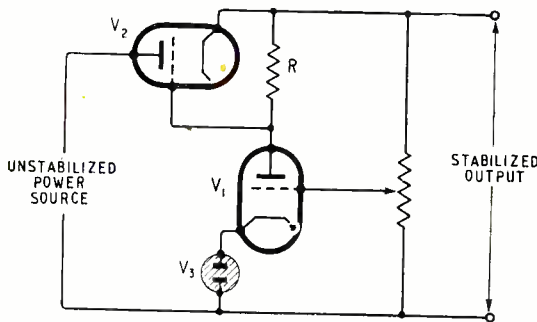

Fig. 5. Essentials of the usual type of voltage stabilizer.

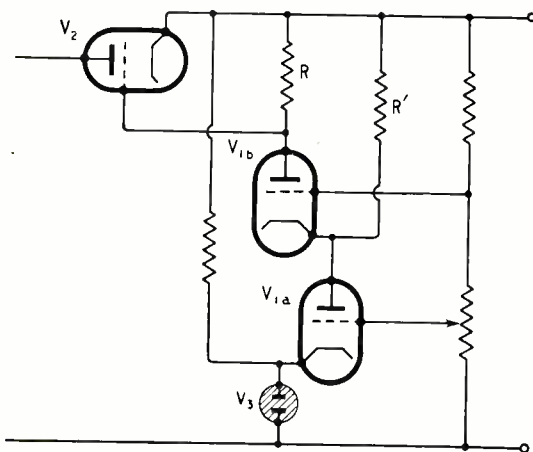

Fig. 6. Modified cascode substituted for V_1 in Fig. 5. The modification consists of R' , which raises the amplification of the stage by increasing the anode current and consequently the g_m of V_{1a} .

ELECTRONIC TELEPRINTING

A NEW electron-image tube that can translate coded signals from teleprinter tape or other sources into clearly defined letters and figures at speeds up to 100,000 words per minute for high-speed photographic recording has recently been developed by R.C.A. In operation the tube simulates the process of typesetting by selecting letters and figures one by one from a "font" and placing them in luminous form on the 5-in circular tube face, either in lines or in any pattern desired. The "font" is actually a lantern slide external to the tube, bearing a chart of letters and figures. An image of this is projected on to a photo-emissive cathode at one end of the tube which emits a stream of electrons in a corresponding pattern. The electron stream is then accelerated forward in the tube by a potential of 100V applied to the conductive wall coating and focused by an external coil providing an axial magnetic field.

The selection of letters and figures in the required order is accomplished by a small aperture of 0.04-in diameter at the neck of the tube which permits only one character at a time to pass through. As the electron stream pattern carrying all the letters and figures moves towards this aperture, a magnetic deflection coil (mounted inside the focus coil) shifts the stream so that only the desired character passes through and travels towards the tube face. Another set of coils then focuses and deflects the character to its proper place on the phosphor screen.

As many as 4,000 characters have been produced clearly in a single pattern on the 5-in tube face. The size of the letters and figures on the screen can be enlarged, however, by the second set of coils if required.

The deflection coils for selecting and positioning the characters contain windings for both vertical and horizontal deflection, as in television. In the teleprinting application these coils are supplied with suitable steps of current in accordance with the coded information which is "read off" (by photo-electric means) from the teleprinter tape.

When the new tube achieves commercial form its initial applications are likely to be in electronic message transmission and in computing systems. Later it may be developed for electronic typesetting.



COLOUR TELEVISION STUDIO, claimed to be the first one built specifically for colour, and recently put into operation by the National Broadcasting Company of America at Burbank, California. An elaborate lighting system with 2,400 controls permits the pre-setting of lighting for ten scenes and also ten changes of lighting within any one scene. An unusual feature is an "audience pit" which accommodates the studio audience below floor level to avoid interference with the cameras.



There is no substitute for the unique experience of the TRIX organisation in the design and development of Sound Equipment. Each unit, whether large or small, is true to the tradition which has made TRIX workmanship respected throughout the world.



Model RE48. A heavy duty reflex type weatherproof horn speaker with exceptional range and performance. Very suitable for all public address work



Enclosed rack type equipment **RGA/633.** Combines 30 watt amplifier with pre-set radio, priority microphone control and 3-speed changer.

THE TRIX ELECTRICAL CO. LTD.
 MAPLE PLACE · TOTTENHAM COURT ROAD,
 LONDON W.1.

Tel: MUS. 5817. Grams. Trixadio, Wesdo, London

RANDOM RADIATIONS

By "DIALLIST"

"Night Starvation"

EVEN in what passes nowadays for summertime, the mains voltage in some localities is liable to fall somewhat after, say, 8 p.m. or a little later. If the fall is not very great and the television receiver is in tip-top form, the effects of this may be hardly noticeable; but with a bigger fall or a set which has been in use for some time without renewals or replacements this "night starvation" can lead to picture shrinkage, with the typical black borders. When that happens the first thing that I suspect is the h.t. rectifier, particularly if it's of the metal type. Metal rectifiers are sound and reliable components, but they don't last for ever and it pays to renew them when tests show that their output is appreciably down. I'd estimate about two years or perhaps a bit more as their normal useful life in an average family set.

A Radio-link Problem

THE temporary East Anglian television transmitter at Tacolneston re-radiates the London transmissions which it receives direct. This has been leading recently to spots of bother caused by r.f. interference from a Continental sound-broadcasting station. I haven't yet been able to find out what station it is. Under certain conditions the interference is fairly mild, merely causing a certain amount of "fish netting" on the picture. But it can at times be bad enough to blot out the picture and to make the accompanying sound almost unintelligible. To prevent viewers in the Norwich area from snowing dealers under with complaints about the misbehaviour of their perfectly guiltless receivers the B.B.C. has very wisely devised a means of letting them know when it's the transmission that is to blame: vertical white bars sent out every so often indicate to the viewer that interference is affecting the transmission.

A Monitoring Suggestion

This idea might, I think, be carried a good deal further, for TV receivers are often blamed by their users for doing things that they can't help doing. Some of the O.B. cameras, for example, "ring" quite severely, producing pronounced white outlines to the right of dark objects. And this

effect can be made worse than ever if a relay is made over a long land-line. An occasional word from the announcer about this might save viewers from worrying about their sets and servicemen from having to make unnecessary journeys. I've a feeling that some, at any rate, of the monitoring should be done with ordinary domestic receivers. Those in charge would then be able to see whether any transmission was likely to cause the sets of Smith, Jones, Brown and Robinson to play up and a word of explanation (and of comfort) could be issued at suitable moments. You know the kind of thing I mean: the sync isn't always able to lock one of the scans—or maybe both of them—properly; a change of camera means a fall in the brightness level, or *vice versa*.

Over-Simplified?

Yes; I know that these things wouldn't happen if TV sets were a little more elaborate—and, therefore, a little more expensive. But, domestic receivers being what they are, the plain and inescapable fact is that they *do* happen. And that brings me to the warning given recently to the radio industry by Harold Bishop, to

whom I offer my humble felicitations on his well-deserved Birthday Honour. What he said in effect was that there are limits beyond which simplification and price reduction cannot reasonably be carried by television receiver manufacturers. And there couldn't be a truer word spoken. Many people feel that these things have been taken too far already. Bringing down prices is fine from one point of view but it's a far from unmixed blessing if it entails, for example, lack of d.c. restoration and d.c. amplification, plus synchronizing arrangements so poor that the picture won't lock unless the signal is bang up to the mark. Myself, I believe that large numbers of folk would gladly pay a bit more for sets that didn't suffer from these shortcomings and whose pictures remained without flutter when aeroplanes were passing by.

The Tape-Recorder Cult

THE tape-recorder is, I suppose, the lineal descendant of the Dictaphone and other similar machines designed originally purely for office use. Today, tape recording has become a hobby whose addicts are every bit as enthusiastic as were the fans of the early days of wireless. To the musical it is of course a great joy to be able to make a record (I nearly wrote "recording"!) of any outstanding broadcast and to have it available when wanted. I must have been quite an early user of the



"WIRELESS WORLD" PUBLICATIONS

	Net Price	By Post
RADIO LABORATORY HANDBOOK. M. G. Scroggie, B.Sc., M.I.E.E. 6th Edition	25/-	26/3
STUDIO ENGINEERING FOR SOUND BROADCASTING. B.B.C. Engineering Training Manual by members of the B.B.C. Engineering Division. General Editor J. W. Godfrey.	25/-	25/6
SHORT-WAVE RADIO AND THE IONOSPHERE. T. W. Bennington, Engineering Division, B.B.C. Second Edition	10/6	10/10
INTRODUCTION TO VALVES. R. W. Hallows, M. A. (Cantab.), M.I.E.E., and H. K. Milward, B.Sc. (Lond.), A.M.I.E.E. ...	8/6	8/10
WIRELESS WORLD TELEVISION RECEIVER MODEL II: Complete constructional details with notes on modernizing the original design	3/6	3/9
RADIO INTERFERENCE SUPPRESSION as Applied to Radio and Television Reception. G. L. Stephens, A.M.I.E.E. ...	10/6	10/11
SOUND RECORDING AND REPRODUCTION. A B.B.C. Engineering Training Manual. J. W. Godfrey and S. W. Amos, B.Sc. (Hons.), A.M.I.E.E.	30/-	30/8
ADVANCED THEORY OF WAVEGUIDES. L. Lewin ...	30/-	30/7
FOUNDATIONS OF WIRELESS. M. G. Scroggie, B.Sc., M.I.E.E. 5th Edition	12/6	13/-
TELEVISION RECEIVING EQUIPMENT. W. T. Cocking, M.I.E.E. 3rd Edition	18/-	18/8

A complete list of books is available on application.

Obtainable from all leading booksellers or from

ILIFFE & SONS LTD., Dorset House, Stamford Street, London. S.E.1.

Dictaphone. Years ago I used to answer a vast number of letters. It was, as you may imagine, the greatest possible convenience to be able to get a few off my chest whenever I felt so minded by dictating my replies into the machine. Once, though, there was a sad mishap. While on a fishing holiday in Devon I recorded a big batch and posted the wax cylinders to my typist. Light-hearted P.O. sorters must have had fun and games with the parcel, for it arrived with all the records in more or less powder form. That, anyhow, couldn't happen with tape.

Balanced or Unbalanced

WHEN television broadcasting was in its youth, I think I'm right in saying that the great majority of receivers were designed for use with balanced twin aerial feeders. To-day all (or very nearly all) use co-axial feeders. I'm told that this means a small reduction in manufacturing costs; if so, I wonder whether it's worth it. Interference seems to become worse and worse and a good deal can be picked up by a co-axial feeder, even though its metallic sleeve is earthed. But balanced twin, with earthed metallic screen and correct impedance matching, picks up little or none; use it and, if need be, a mains suppressor and you'll get no interference except what is actually picked up by the aerial itself. Some time ago I was using an "H" aerial over 100ft from the nearest road and nearly 60ft above its surface. Motor-car interference was a nuisance with a coaxial feeder in use; a change to balanced twin, with the necessary alterations to the receiver and careful impedance matching made all the difference in the world.

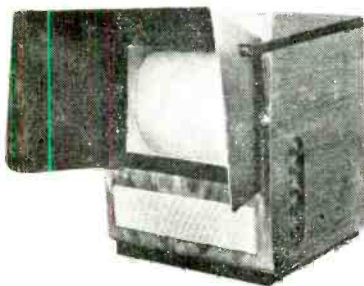

TELEVISION SCREEN MASK for shielding the tube face when viewing in daylight or with the room lighting on. Made from compressed fibre material with a light-absorbent inside lining, it is fixed to the front of the set by rubber suckers and secured by an elastic strap. Available from Vendoma (TV), Station Buildings, Preston Park, Brighton, in sizes for 12-in, 14-in, 15-in and 17-in receivers.

"THE CHOICE OF CRITICS"

The RADIO SHOW

EARLS COURT AUG. 25 - SEPT. 3
STAND No. 59

Once again, but even more vast, the entire range of Bulgin Electronic Components on show at the 22nd National Radio Show, will include all added new and improved models. You must make a point of visiting stand No. 59 and inspecting this comprehensive display.

New Components on show will include

Sealed watertight and airtight Signal Lamp Fittings manufactured to Inter-Services Specifications. Coloured P-F-U Lens Caps with metallic insert rim and perbunan seals and socket insulation. Metal parts silver plated to 7/2/2-RCS.1000. Moulded panel insulating bushes.

The **Non-Sealed Version** is of matching appearance and has the same Lamp acceptance (M.E.S.) and is also made to Inter-Services Specifications.

Valve-Top Connector with extra tag for resistor inside screen.

PolyMicro. This New gangable, mains, rotary micro-switch is now made in a 12-unit standard version to augment the already popular 6-unit model.

If you cannot visit the Radio Show at Earls Court, then send for a copy of the latest Bulgin Catalogue (REF. No. 194/ww) Price 1/-d. post free.

BULGIN

A. F. BULGIN & CO. LTD.
BYE-PASS ROAD,
BARKING, ESSEX
Telephone R1Ppleway 5588 (5 lines)

UNBIASED

By FREE GRID

Peccavi

IN the June issue I mentioned that I was going to try to accelerate the growth of plants in my garden by exposing them to the radiations of an r.f. oscillator. I had been interested in an item of news received from the U.S.A. which said it had been noticed that in the neighbourhood of high-powered television transmitters a veritable jungle of luxuriant undergrowth had sprung up.

I found I was quite mistaken in thinking that there was anything new in this as I have been sent several photographs (one of which is reproduced) and data concerning the growth of r.f.-nurtured plants as far back as 1939. The two hyacinths on the left of the picture received radio treatment (50 Mc/s) and flowered 15 days earlier than the untreated one shown with them. I can only say I feel ashamed of my own ignorance.

In the June issue I also discussed early talking machines and a reader has tried to put me on the penitent's stool for this by implying that I said that needles and not sapphires were *invariably* used with disc records. To

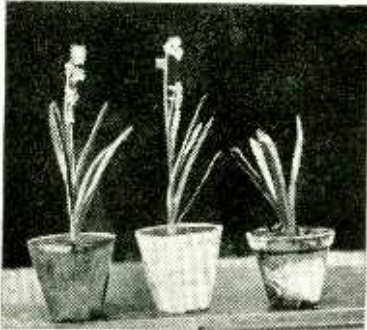

Electronics in the garden.

prove me wrong he has sent me an Edison sapphire-using disc but adds "I see that, with true legal caution, you have left yourself a loophole."

What I certainly did *not* know was that some disc machines used a screwed rod to propel the sound box across the record. I thought that with discs this was invariably done by the needle running in the groove as in modern machines. This is not so, however, and the makers of the record took pride in announcing that the grooves were too shallow to have the task thrown on them of pushing the sound box along; records are made of sterner stuff nowadays.

Mummified Music

I WAS very impressed by the demonstrations given in the Royal

Festival Hall in May of the degree of hi-fi which can be achieved in mummified music by modern methods of recording and reproduction. It is given to a very few to be able to listen to a chronologically and topographically side-by-side comparison of the real thing and an embalmed version of it. Despite the fact that the hall was packed to capacity, the audience was very small compared with the number who would have liked to be there.

It is unthinkable that there should not be a repeat performance in a few months' time and I have been trying to think of a method whereby a larger audience could be reached. Mrs. Free Grid made the tom-fool suggestion that the B.B.C. should be asked to put it on the air. Apparently it did not occur to her that the music-mangling properties of the ordinary domestic wireless receiver would reduce the living and the mummified performances to the same low level; in fact, the embalmed version could be made to sound better than the real thing, for special recordings could be made to compensate to some extent for the deficiencies of the average set.

In a few years' time when there will be a hi-fi receiver in every listener's home it will be a different thing. But even to-day the number of f.m. set owners is certainly much greater than the seating capacity of the Royal Festival Hall. To hear the programme on v.h.f. would certainly not be the same as hearing it in the flesh.

All the same, I for one am willing to agree not to apply for a ticket for the next demonstration but to listen at home and let my seat be occupied by somebody less fortunate than myself who is at present beyond the reach of v.h.f. either for geographical or financial reasons. I, therefore, appeal to all other f.m. people to make a similar offer and to the organizers of the demonstration to approach the B.B.C. in the matter.

Electronic Morphimeter

I WAS interested to learn that an electronic device has been developed for gauging the depth of sleep or unconsciousness by measuring the skin resistance, which apparently varies in step with it. Surely this should have many applications other than the medical one mentioned. Apart from its obvious use in the boxing ring where it would enable the referee to see at a glance the exact condition of a recumbent pugilist it supersedes the existing form of baby alarm first described in this journal nigh on thirty years ago.

This old type alarm, as you may

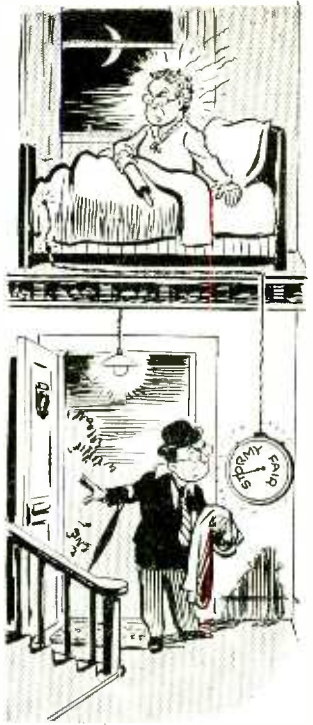

Further outlook unsettled.

remember, consisted of a mike suspended over the cot so that the nasty noises emitted by a baby are conveyed to the doting parents below. With this new device the changing resistance of the baby's skin as it approaches bawling point could obviously be caused to operate the alarm, thus obviating the mental trauma which a well-known psychiatrist has stated that babies receive when their immediate wants are not anticipated.

I would like to point out, however, that this idea of a morphimeter is not quite as new as it seems. The varying skin resistance on which its action depends is caused, I understand, by the fact that the rate of metabolism in the body changes according to the degree of unconsciousness. This changing rate of metabolism not only varies the skin resistance but has the same effect on the dielectric constant of the body.

Long years ago I fixed up a capacitor, the two electrodes of which were the bedspring and the wire mesh of an electric blanket which Mrs. Free Grid always uses. Her body was, of course, the dielectric and I found that the capacitance of my crude device varied according to the depth of her sleep. I put this to practical use by causing it to operate an indicating meter downstairs so that on those occasions when I was detained late at the office I could avoid creeping upstairs to bed until I was assured that she was really sunk in a deep sleep.